

**NMRA SER 2017**  
**Crossroads of Dixie**  
**LCC (Layout Command & Control)**

Compiled by: Dick Bronson  
RR-CirKits, Inc.

**Basics of LCC.**

[www.rr-cirkits.com/clinics/SER-2017-LCC.pdf](http://www.rr-cirkits.com/clinics/SER-2017-LCC.pdf)

# Layout Command Control



# What is LCC?

**LCC is an information highway  
for your model railroad layout**



# What is LCC?

- **LCC is a common language for layout elements to talk to each other**

- Signals
- Turnouts
- Detectors
- Lights
- Panels
- PCs / Smart Phones
- Boosters
- Command Stations
- Throttles
- Power Managers
- Trains
- etc...

# What is LCC *NOT*?

**LCC does NOT replace DCC.**

On the track – DCC

Beside the track – LCC

LCC is not dependent on DCC,  
could run on DC or Märklin layouts  
not locked to the DCC manufacturer

# Why LCC?

- I have heard it said that LCC is a solution looking for a problem, because we already have many ways to control our layouts.
- That is true, and it is part of the problem. We have LocoNet, CMRI, XpressNet, MERG, plus many other proprietary methods to connect our devices.

# Why LCC?

- Many of us simply use the DCC itself to control devices. That has two problems.

First it is a one way street. Have you ever seen a DCC connected detector? (yes, Railcom could possibly do it)

Second, DCC is limited in bandwidth, and competing with the locomotive control information.

# Other Options

- What about LocoNet, CMRI, XpressNet, MERG, plus the many other proprietary methods to connect our devices.
- Most of these solutions originated due to the difficulty in using the DCC bus for any input information.



# Other Options

- CMRI was actually the first system to allow for two way communication with the layout. In my opinion its primary drawback is its Master/Slave nature.
- A CMRI system always requires a single master computer to control everything. Until recently it was also proprietary.
- No CMRI node can communicate directly to another.

# Other Options

- The LocoNet was the first Peer-Peer model railroad network that allows any device to talk to any other device without any master unit in being in charge. (except during programming)
- Unfortunately the LocoNet is proprietary and requires licensing for commercial use.
- The LocoNet operates only slightly faster than DCC itself.
- The LocoNet does not overload gracefully.

# Other Options

- The XpressNet is also a Master/Slave network with the same limitations as CMRI, and has little US presence or support.
- The UK based MERG group have many excellent designs, but they require an annual membership fee to access many of them.

# A solution is proposed

- The NMRA decided a number of years ago to sponsor an open (license free) method to interface to your layout. The intent is that, like the DCC standards, many manufacturers will be able to build layout accessory products that will interchange as freely as is now true for DCC mobile decoders.

# A solution is proposed

- The bus must use license free commercial standards for its communications as much as is possible.
- It should be robust and viable into the next generation of electronic products.
- It should be a peer-peer design with no requirements for any central control.
- Any two devices from any manufacturers must be able to exchange data.
- The Open LCB group was chosen to develop this.

- The result was a set of protocols that can be sent over any media. For example, EtherNet, Wi-Fi, CAN (Control Area Network), and others. (some say tin cans and string, but don't believe it)
- The NMRA calls this Open LCB standard LCC. Layout Command and Control. LCC is NOT a replacement for DCC. (unless you consider replacing DCC accessory decoders)
- LCC can run along side of DCC, AC, DC, DCS, TMCC, RailPro, Battery power, etc. It is not a way to power your trains, it is a way to control your layout.

# Why CAN?

- It is important to remember that LCC can be transported over many network technologies.
- When we (RR-CirKits, Inc.) decided to build LCC devices we had to make a choice of which transport to use. Wired Ethernet was one option, but designing a peer-peer network for Ethernet was way above our pay grade. The other problem is that it would require multi port Ethernet Switches with direct cable connections to each device. This would require more wiring, not less, than current options. Wireless has issues with many nodes, and putting a radio in every node seems like a complex and costly solution as well.

# Why CAN?

- CAN was initially developed as a solution for automotive networking. This means that it is noise tolerant, an industry standard, and designed for the 12-24V world. CAN can be operated over a wide speed range, with a linear trade off between bus speed and bus length.
- The OpenLCB engineers picked a 125Kb rate and 1000' length as a good compromise for model railroad use. This is an order of magnitude faster than DCC.
- Also, unlike the other popular Peer-Peer system, CAN can operate continuously at 100% data throughput with error free collision resolution.



# Why CAN?

- Disadvantages. The relatively high CAN bus speed does not allow for free form network designs. A CAN network segment requires a linear bus with a termination at each end.
- Due to timing and other electrical limitations a single CAN segment is limited to 40 or fewer physical nodes. There are fairly simple ways to expand a CAN network into multiple segments, so this is not a serious concern.

# Why CAN?

- CAN has several different cabling and connector standards. Some of these use large and costly connectors. Often CAN uses the same DB-9 connectors used by RS-232 serial cables. These are still relatively large and no longer so very easy to locate, especially in longer lengths.
- Another CAN connector option uses the same RJ45 connectors and cables as wired Ethernet does. The OpenLCB engineers opted for these RJ45 connectors because of the relatively low cost and their common availability world wide. The 4 pairs of a standard Ethernet cable additionally allow for optional power and other signals in addition to the CAN data pair itself.

# LCC Basic Concepts

- Its the Event ma'am, just the Event.
- In previous control systems using a bus and events, (e.g. LocoNet and in a lesser sense CMRI) the events or messages sent on the bus have two parts, first an identifier number (address), and second the message type. This follows the original code line concept where each event was a station number plus one or more commands. For example: *turnout #23 set normal*.

# LCC Basic Concepts

- This is:
  1. a Turnout command
  2. for station #23
  3. set normal
- A matching command with a predefined one bit different would mean *turnout #23 set reverse*. Another one bit change would create *turnout #24 set normal* etc.
- The size of the command space and the protocol design limits the number of possible options to a predefined set. (e.g. 2048 turnouts, 4096 sensors, etc.)

# LCC Basic Concepts

- For example turnouts only have two options, normal and reverse. If you have a three way turnout, (very rare on the prototype) sorry, you need to think of it as 2 two position turnouts. Have a three color signal, sorry, you need to think of that as either three different on, off, messages, (CMRI) or else combine two 2 position messages. (LocoNet) What about a more typical eastern signal with 5, 6, or even more aspects?

# LCC Basic Concepts

- In the LCC world an event has no predefined meanings. None, Keiner, Nada! An LCC event simply says; 'something has happened', or 'something should happen.' How it is defined is 100% up to you, the user. In our previous example it could still mean *turnout #23 set normal*. However with LCC 'turnout #23' is just what you call it on your layout, not that it was pin 23 on some brand of hardware controller. *Set normal* just means that the event moves the turnout to normal. Undoubtedly you will want another event to move the turnout back, however that will be a completely different event with a different meaning. (e.g. *turnout #23 set reverse*)

# LCC Basic Concepts

- Maybe you want all turnouts to move to normal when you first start up. With our conventional control bus you need some way to send the proper commands to each turnout. (sometimes called Routes) With the LCC system you could simply define a new Event that says '*all turnouts normal*' and then configure each turnout to also respond to that command (by moving in the appropriate direction)

# LCC Basic Concepts

- **Producer - Consumer** You will probably hear LCC folks throwing around terms like Producer and Consumer. They aren't talking about a big business takeover. They are just trying to sound educated. <G>
  - *Producer* simply means that some device can create (produce) an Event. Some examples might be a push button or block detector.
  - *Consumer* just means that some device can respond to (consume) an Event. It could be a lamp, a turnout driver, or anything else that you can control.
  - *Events* can have from 1 to many *Producers*. Events can have from 0 to many *Consumers*.

<http://openlcb.org/trunk/documents/notes/ProducerConsumerModel.html>



# LCC Basic Concepts

To elaborate a little bit. For an event to happen something must have sent it. Therefore there has to be at least one *producer*. In the LCC world it is possible for many different *Producers* to create the same event. For example you might want to have turnout control buttons track side and on a remote panel. Thus the statement that every Event has one or more *producers*.

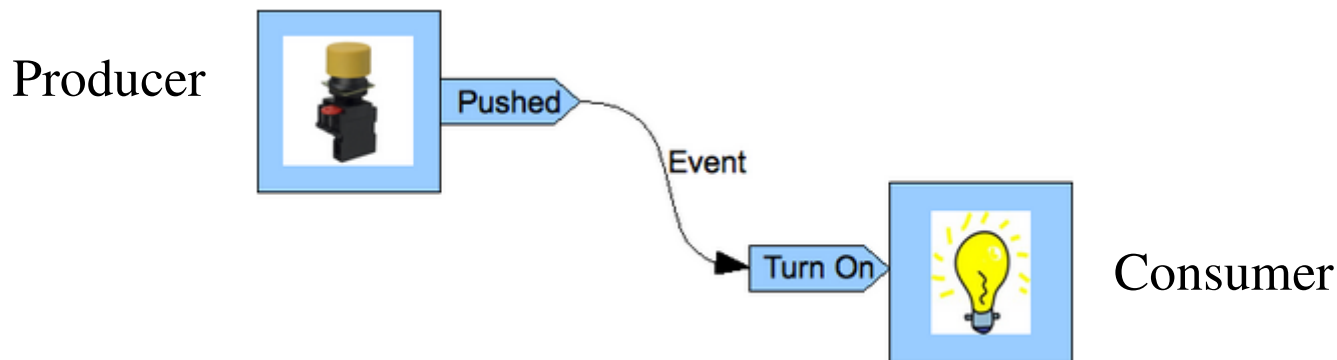

# LCC Basic Concepts

For *consumers* the picture is a bit different. There is nothing in the specification that says any device has to respond to an Event. You may have built a panel for a passing siding that doesn't yet exist. If you press its turnout control button an Event message gets sent out. (*producer*) However there is nothing to respond. (*consumer*) Later you might add a turnout controller and a computer based CTC machine and have several *consumers* for that Event. Thus the statement that every Event has zero or more *consumers*.

# LCC driving Signals

- Application to Signals

Signaling usually requires more logic than can be handled via simple Events, e.g. occupancy, turnout position, look ahead to the next signals, etc. However a signal controller could be designed to listen to all of the appropriate Events and fully control the signal aspects. Note that it's still useful for a signal system to emit (produce) Events for each aspect change so that e.g. a control panel can mirror the appearance of the on-layout signals, or so that the next signal can know its aspect.

# LCC driving Signals

- In the following examples we will compare different methods of controlling signals. This varies from individual LEDs to a full blown track side control point.

- Signals via individual lamp drivers

You can connect the lamps of a signal head to individual Consumers:

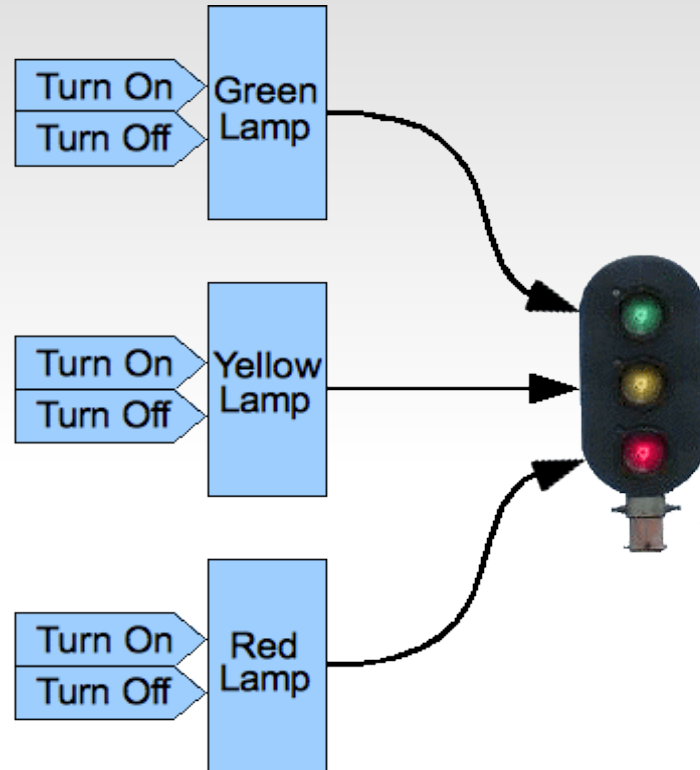

This is a powerful but complicated approach. It requires that the controller individually turn each lamp on or off. This can cause excessive control traffic and potentially poor timing of flashing signals. This is the method used by CMRI and currently (as of June 2017) available LCC equipment.

- Signals via individual head drivers

You can also control signals with Events for the specific colors or functions of a single head.

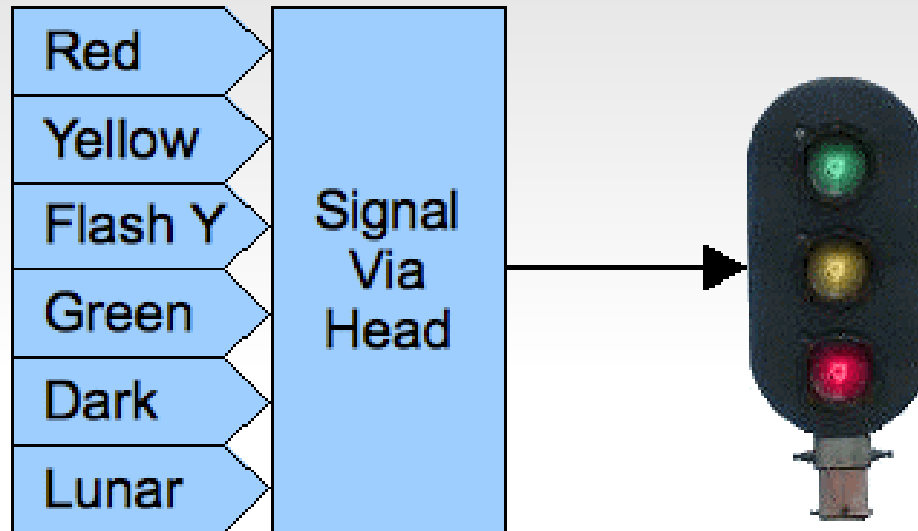

This method requires less command traffic than the previous one. However, if the controller does not know how to flash the signals, it may still result in constant streams of messages to be able to show flashing aspects. The Digitrax SE8c falls into this category. It normally only displays Green, Yellow, Red, and Dark. To show 'Flash Y' you need to alternate between sending Yellow and sending Dark. Got Lunar? Nope!

## ■ Signals via aspect drivers

You can control an entire signal mast with just one Event for each high-level aspect of the signaling system.

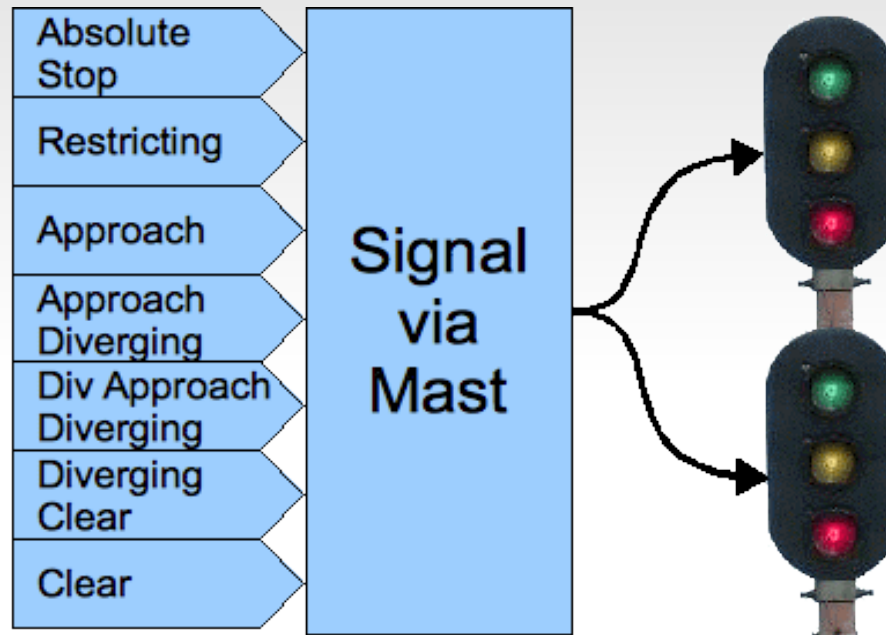

This method requires the minimum amount of command traffic to control the signals themselves. However it still requires an external controller or a program such as JMRI to monitor the layout and calculate the proper aspects. Our RR-CirKits SignalMan in NMRA Signal Aspect mode falls into this category.

- Signals via control point drivers

You could also control an entire interlocking with just single Events for each high-level aspect of the signaling system including turnout position.

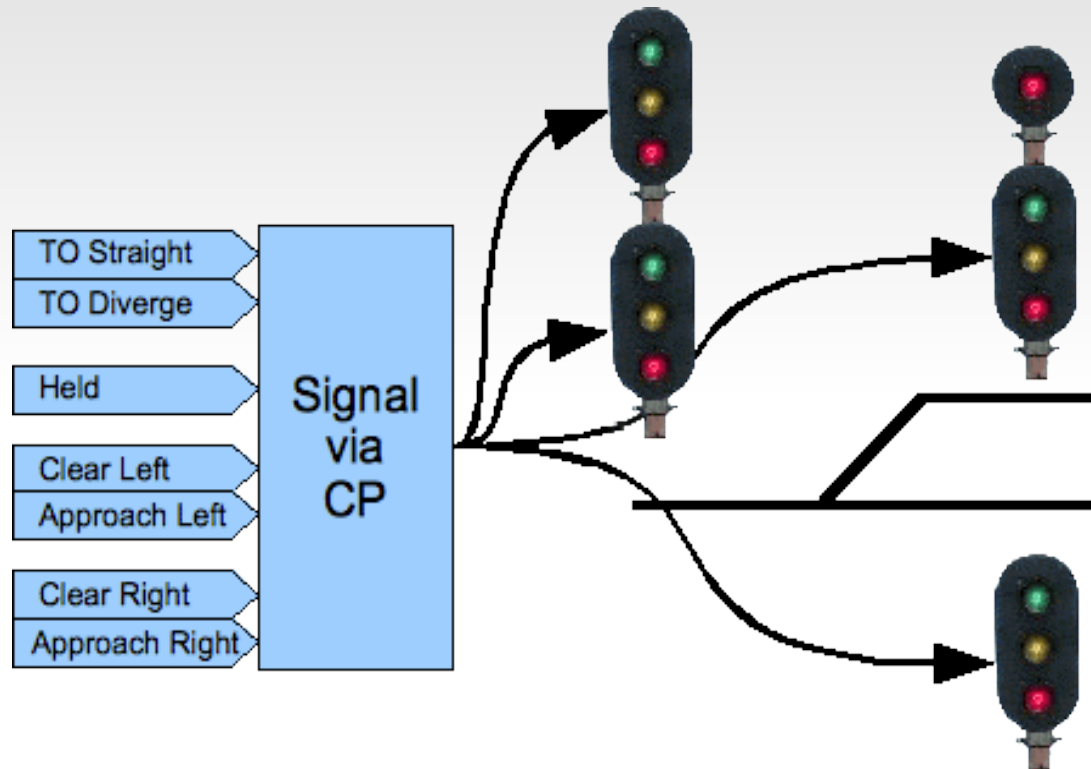

This method is similar to the signal aspect driver, but includes turnout control and possibly even occupancy detection on the same node. However it still requires an external controller or program such as JMRI to calculate the proper aspects. The RR-CirKits LNCP is similar to this option.



## ■ Integrated Signals

In each of the examples above, the signal controller uses (consumes) Events that directly control the appearances of the signals.

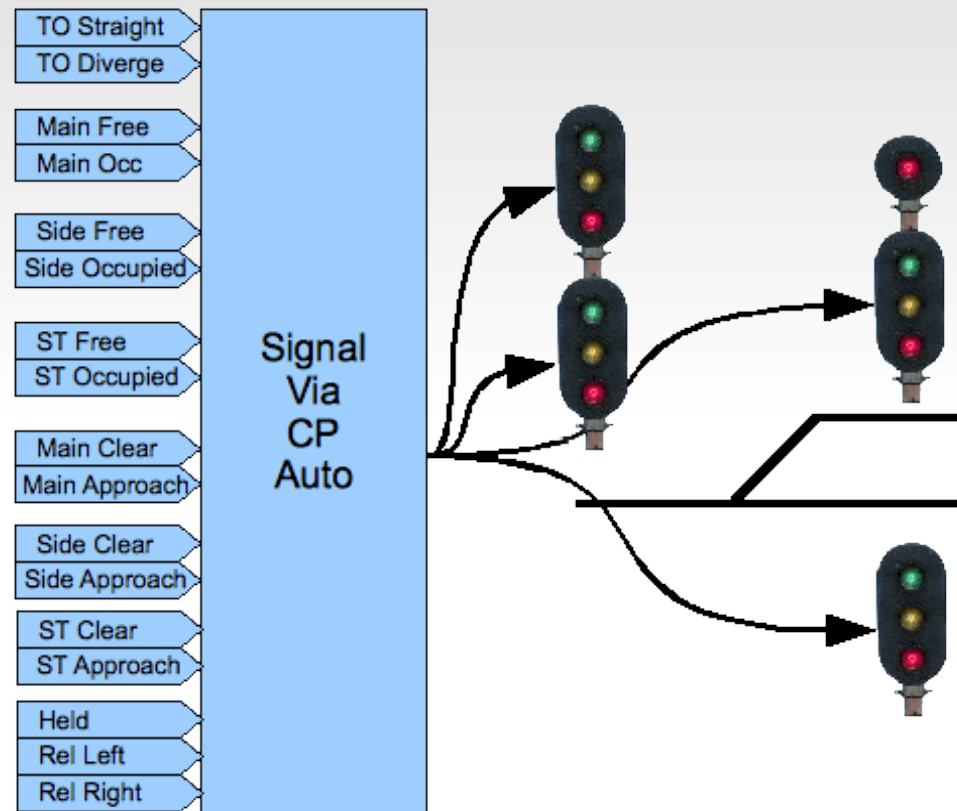

It's also possible to build a signal controller that watches all related status Events from the railroad and CTC panel and makes independent decisions about the proper signal states and appearances. This type of controller would control its signals without any external computer involvement.

## ■ LCC Background

At the Detroit NMRA National back in 2007 the NMRA was seeking a network standard to be known as NMRAnet for layout control. They proposed that the Manufacturers Working Group create a standard in a 6 month time frame. (if my memory serves me correctly)

LCC grew out of a concept first presented by John Socha-Leialoha during a lunch meeting in the food court following that meeting. John proposed that the PC (Producer Consumer) model be used by this new standard, and proceeded to try to explain to some of us gathered around the table just what he meant by that. Time and politics passed, and the NMRA tentatively accepted one early proposal. However, other folks didn't agree and formed an independent project known as...



More time and politics passed, and the NMRA finally decided to get out of the specification writing morass, and turned that job over to the original OpenLCB group.

- Fast forward to just prior to the Cleveland NMRA National in 2014. The NMRA went back to the OpenLCB group and gave them an ultimatum. Present a proposal to the NMRA or they would declare the project as dead. This created a new sense of urgency and the basic specifications were presented to the NMRA in time for the early 2015 board meetings. Unfortunately in the rush to publish something, some key features were omitted, so it was late 2015 before we (RR-CirKits, Inc.) felt that the specifications were mature enough to actually start delivering hardware. Specifically we wanted our users to have an approved method for upgrading their products.
- With the NMRA approval came their new branded version of the OpenLCB specifications. They call it LCC. (Layout Command and Control)

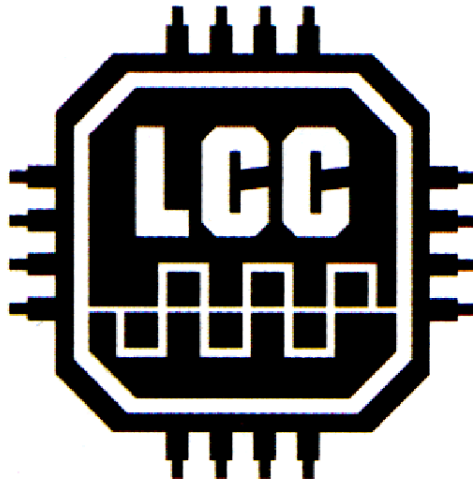

# Early Hardware

- One of the first manufacturers of CAN based layout control nodes was the MERG group. They proposed that the NMRA accept their protocol. In fact some of the early development work was done using their hardware.
- Another early proposal came from Don Voss. (brother of Di Voss) It was Don's proposal that was originally entertained by the NMRA as the NMRAnet.
- As I previously mentioned, the OpenLCB group felt that these protocols were too restrictive to be chosen as the next generation standard, so they pushed forward with their own ideas and protocol proposals.
- Fortunately there were some in the NMRA that were taking notice.

- One of the first manufacturers of OpenLCB nodes was Tim Hatch of TCH Technologies. A couple of Tims products are shown here.

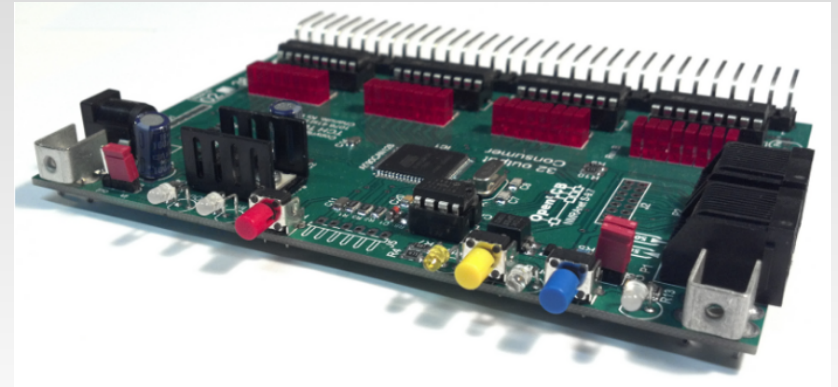
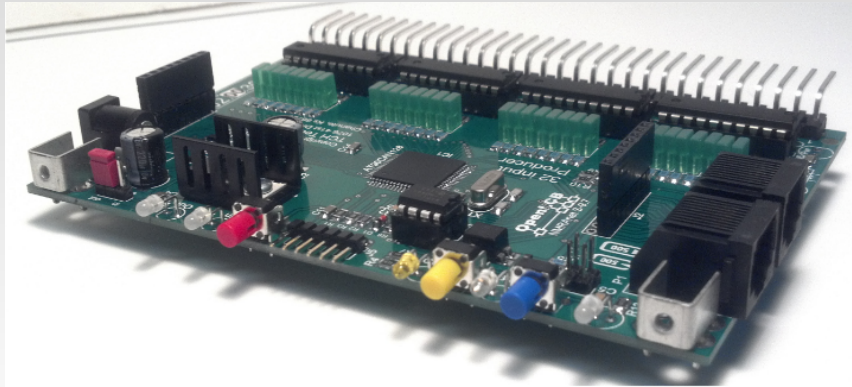

These early boards were essentially OpenLCB replacements for the 32 line Bruce Chubb input and output boards. They were developed as a way for the developers to run real hardware to prove out the specifications. Unfortunately they have the same limitations as their CMRI equivalents in that they are strictly input or output slaves to a computer program. These boards are no longer available nor supported by recent JMRI versions.

TCH also manufactured the first CAN bus to USB interface available for the OpenLCB.

- Another early hardware developer was Don Goodman of Railstars. His OpenLCB board includes both inputs and outputs. It is called Io. (named for the Jovian moon)

<http://railstars.com/hardware/io/io/>

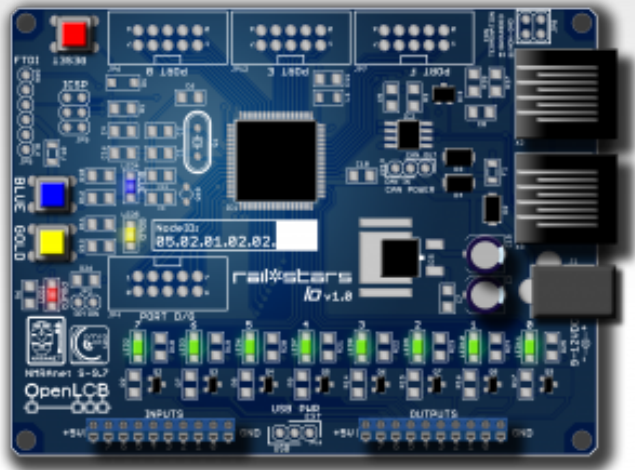

As far as I know the Railstars Io board is no longer available. However, like the TCH boards, the Io supports just two producers or consumers per line, so it is essentially an I/O board tied to a computer program.

# Configuration of LCC nodes

- One of the key new concepts in the LCC protocol is that, not only the configuration, but the 'decoder file' (in JMRI terms) itself should reside in the LCC node. This is an important change from the status quo.
- Originally hardware had a fixed purpose. Each required its own dedicated connections. Lionel crossing gates flashed with contacts triggered by the passing wheels. (blink-blink....blink-blink....)

# Configuration of LCC nodes

- Then some devices were connected to a bus. (or track) This required assigning addresses or channels. The usual solution for addressing was to include a set of jumpers or switches for the selection. In some cases it was a plug with different component values.
- As electronics improved the selection of addresses was moved into the device code itself. An example that we are all familiar with is modern DCC mobile decoders.



# Configuration of LCC nodes

- One of downsides of this new method is that our decoders now need to be configured with a new (non default) address. That itself was automated by some manufacturers, but it soon became evident that something more was needed than simple interactions through a hand held throttle. Some new decoders currently have 1000 or more values to configure.

# Configuration of LCC nodes

- JMRI and other programs have come to the rescue, but the decoders are now so complex that a 'decoder file' is required for each locomotive and stored on a computer to help keep track of changes. The DCC specification does not include an easy way to read information from a decoder except very laboriously and slowly over a special connection. (called a programming track)

# Configuration of LCC nodes

- This manual address assignment was deemed to be too slow and inflexible for the new LCC equipment. Two key changes were required. The first was that any LCC node could be configured in place on the layout at any time with no need to access it for jumper changes or button presses. The second was that any information required to configure a node should reside in the node itself, and be available to any configuration tool connected to the network. Now any node could be configured in one place and moved to another with all the information moving with the node itself. This means not only configuration values but user names and comments as well.

# Configuration of LCC nodes

- Another key design choice was that the manufacturer would assign a node ID during manufacturing in a manner that prevents any duplication of addresses.... Ever, .... anywhere! (similar to Ethernet MAC addresses)
- This manufacturer based address assignment has another unforeseen benefit. Any automatic or user linking of two LCC nodes no longer needs to know anything at all about the rest of the layout in order to prevent unintended conflicts.

# Currently Available LCC Hardware

- We at RR-CirKits watched all the above history unfold, and when we figured that the smoke was mostly cleared, we started the design cycle on a family of CAN based OpenLCB boards. (now NMRA branded as LCC) This initial development process was delayed due to a missing firmware upload protocol, but we finally started shipping hardware to our first customers in January 2016. (a year after the NMRA accepted the current protocol)

# Currently Available LCC Hardware

- Our (RR-CirKits, Inc.) current product line includes just the basic items required to start investigating the new LCC bus. We chose our first I/O node to be compatible with our existing product line of daughter cards. This allows the user to do basic train detection, turnout control, and similar functions using available hardware options.

# Currently Available LCC Hardware

- Power – The LCC CAN bus has two basic options for power supply to the nodes. The first is to supply power to each node. The second is to power the nodes from the CAN bus cable. Of course a node can also do both. (some early hardware did that) Because one of the desirable features of the LCC is to eliminate as much layout wiring as is practical, we chose the second option. We suggest that the user supply power to the bus as required by using our Power-Point module and/or our LCC Repeater module.

# Currently Available LCC Hardware

- Termination – The LCC CAN bus is much faster than any existing layout control buses, so it requires termination at both ends for proper response. The standard allows this termination to be part of each board, using jumpers or switch selection, or to be separately provided.
- We chose the latter option because we feel that it is less likely to be configured incorrectly. The only place that the terminators may be easily connected are at each end of a bus segment, just exactly where they are required, and no place else.



# Currently Available LCC Hardware

- Cables – The CAN version of LCC was specified to use the commonly available CAT5, CAT5E, and CAT6 cables with RJ45 connectors. The industry standard pin out for CAN over CAT5 was chosen. This was done so that the user could easily purchase or construct his own cables. The 4 and 6 conductor silver satin cables used by some other manufacturers are no longer as easy to find as they were 20 years ago. The two different systems (CAN and Ethernet) that use these cables supposedly will not suffer damage if the cables are cross connected accidentally between networks. Of course neither network will work in that case.

# Currently Available LCC Hardware

- With the recent addition of an option to place the DCC rail sync information on an otherwise unused pair, CAN can now support smart boosters.
- I have referred to the CAN version of LCC. Remember that the LCC protocol is also capable of being used over different systems, Ethernet, and Wi-Fi also being developed for use by other LCC developers.

# Coming LCC Hardware

- The next node we designed is a Signal Driver. Firmware is under development.

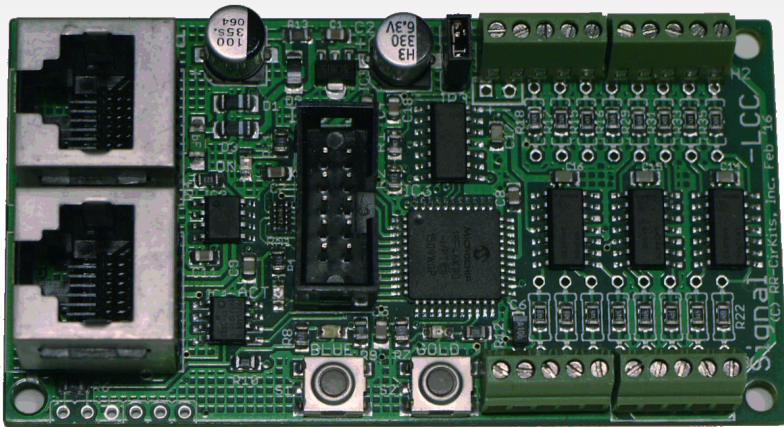

## Signal-LCC

True aspect-based signaling  
Easy to configure logic  
Max. 8 signal masts, 16 LEDs  
Up to 32 aspects

Plus 8x I/O lines (like the Tower-LCC)

# Coming LCC Hardware

- RailCom Detector under development.  
(development image shown)

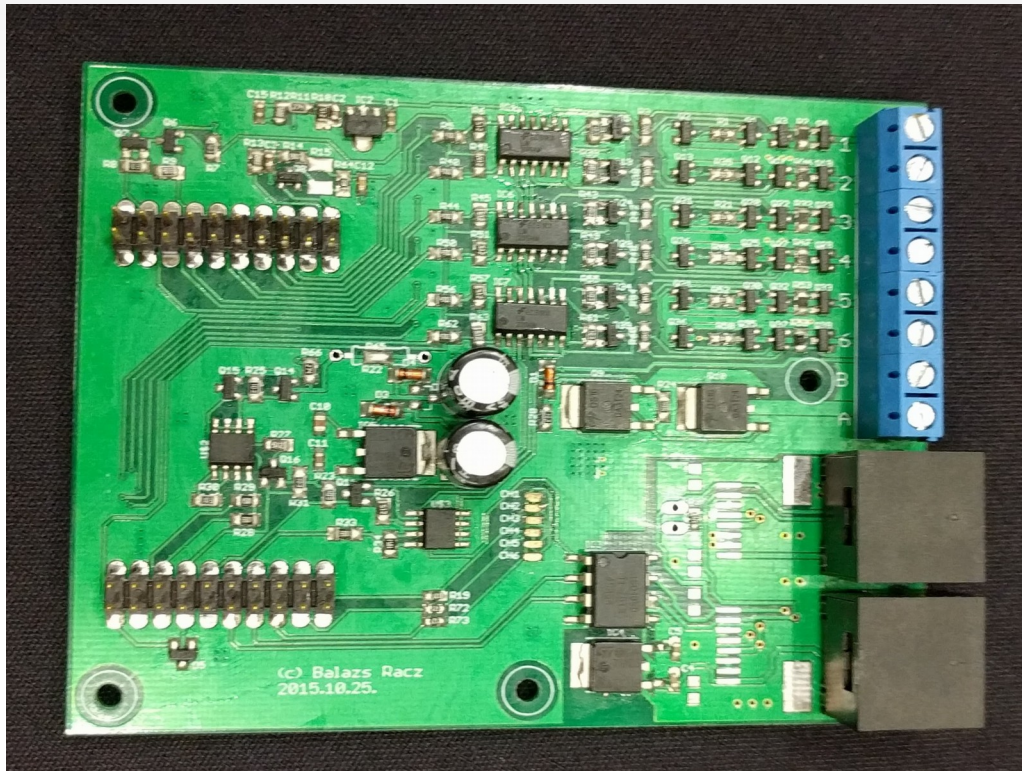

8-channel  
Block occupancy detector  
Adjustable sensitivity  
Feedback via LCC  
Circuit breaker  
Adjustable current limit  
Turn off staging track  
Railcom to determine which  
train is on the track  
Loco CV readout POM  
Staggered block power  
turn-on  
Auto reverse channel

# The Future of LCC

- Smart Detector, Railcom, Circuit Breaker, Reversers
- Simple Detector, CT coil based.
- Stall Motor Driver (Support for ganged Tortoises, MP1, etc.)
- Dual Coil Solenoid Driver.
- LocoNet to LCC Gateway. (LCC support for existing products)
- Ethernet Links.
- Wireless Links.
- Throttles
- Smart Boosters, Command Stations.

# LCC Configuration Tools

- Because all the configuration information as well as the values, user names, and comments reside permanently in the nodes themselves, it is easy to use different configuration tools interchangeably. There is no need to synchronize them externally or move files around from computer to computer.

# LCC Configuration Tools

- This node information is stored in the node as a CDI file. (Configuration Description Information) The CDI is in .xml format, but because it references internal register locations it is not advisable to attempt making any changes manually.

Example CDI info as stored in a node:

```
<?xml version='1.0'?>
<cdi xmlns:xsi='http://www.w3.org/2001/XMLSchema-instance'
xsi:noNamespaceSchemaLocation=
    'http://openlcb.org/schema/cdi/1/1/cdi.xsd'>
<identification>
<manufacturer>RR-CirKits</manufacturer>
<model>Signal-LCC</model>
<hardwareVersion>rev-A</hardwareVersion>
<softwareVersion>B-1</softwareVersion>
</identification>
<segment space='253'>
```

- The original CDI tool was created as a part of JMRI.

[www.jmri.org](http://www.jmri.org)

Select OpenLCB and choose 'Configure Nodes'

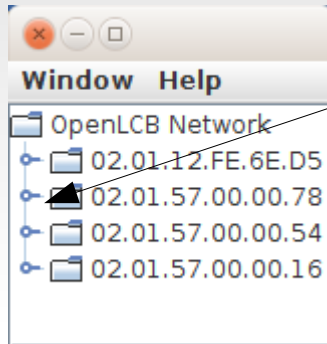

Next open the node you need to configure.

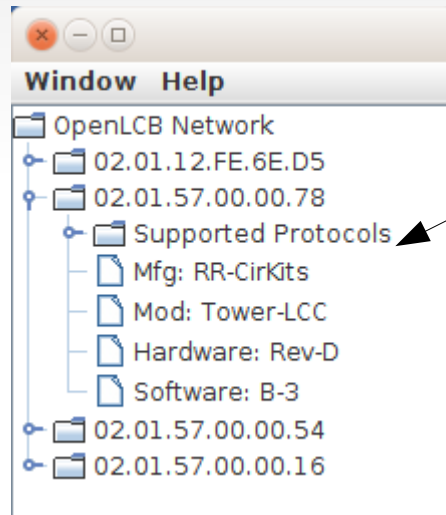

Open 'Supported Protocols'.

Then choose 'CDI' to open the JMRI CDI tool and read the node.

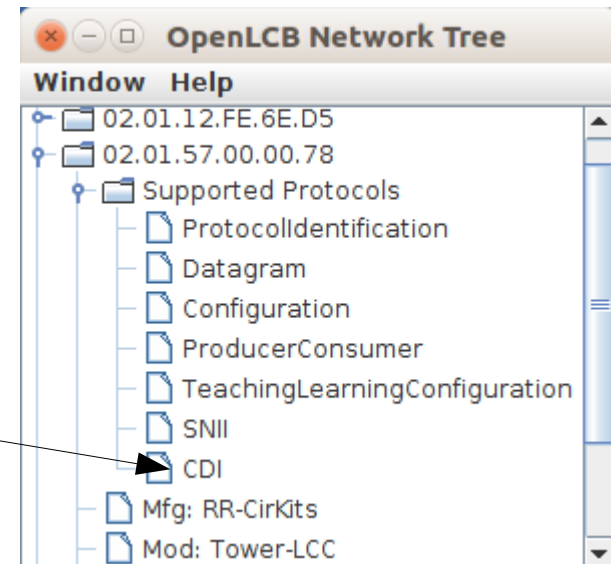



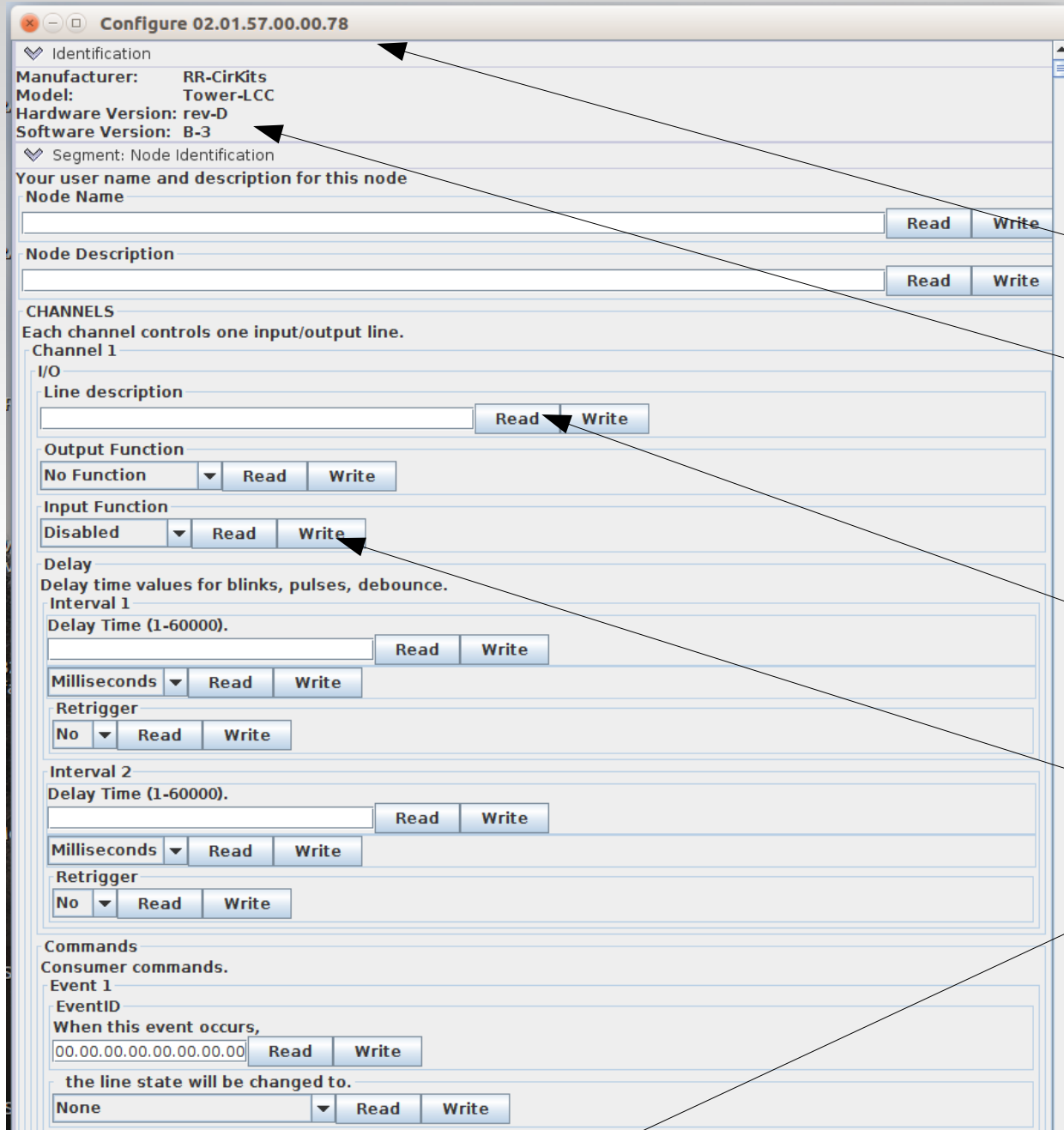

This will open the JMRI CDI tool window and allow you to read and write data to the node. The window header shows the node ID that is open and the Identification shows some basic data about the node.

The actual data will not show up unless you choose to 'Read' it from the node. If you make any changes to the information, then you must 'Write' the data to store it into the node.

There is a 'Read All' button at the bottom of the window, but be forewarned, it takes a lot of time to read all of the data in.

Because LCC is an open standard anyone can develop tools for it. One such developer is Robert Heller of Deepwoods Software. This is part of his model railroad software package.

<http://www.deepsoft.com/home/products/modelrailroadsystem/downloadmr/>

Run the OpenLCB tool.

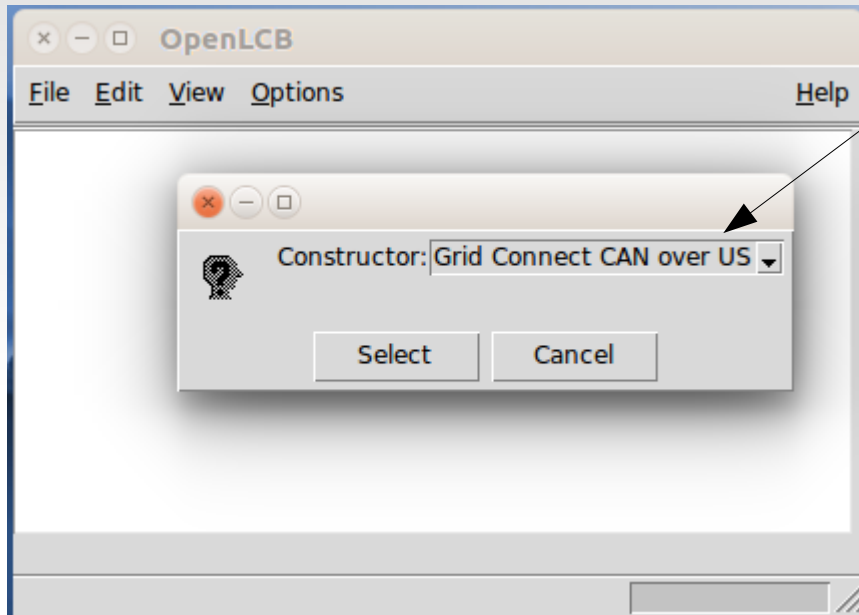

If you are using the LCC Buffer-USB as your interface device, then select 'Grid Connect CAN over USB' .

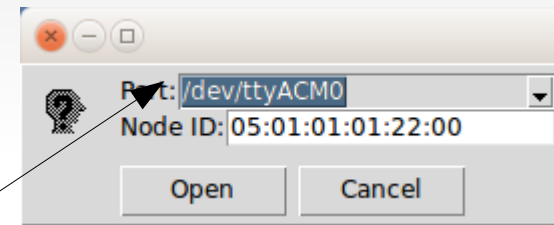

Next select the proper COM port. (this example is on Linux)

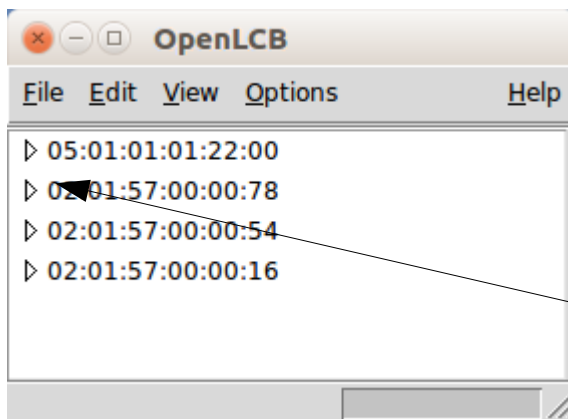

Once you click on 'Open' a similar window to the one you saw in JMRI will open. The first entry is the program connection itself. The other entries are a list of the attached nodes.

As in JMRI, open the node you choose to configure by expanding its tree view.

Robert's CDI tool opens a bit differently than JMRI. You need to drill down in the tree to see more information.

However, because the information actually is stored in the node, you should see exactly the same data.

The CDI tool is started by clicking on 'CDI' just as it was in JMRI. However, If you missed the LCC traffic indicators, there is no visual feedback that anything has happened, and it may take a long time before the CDI window loads and finally opens. Resist the temptation to click it again.

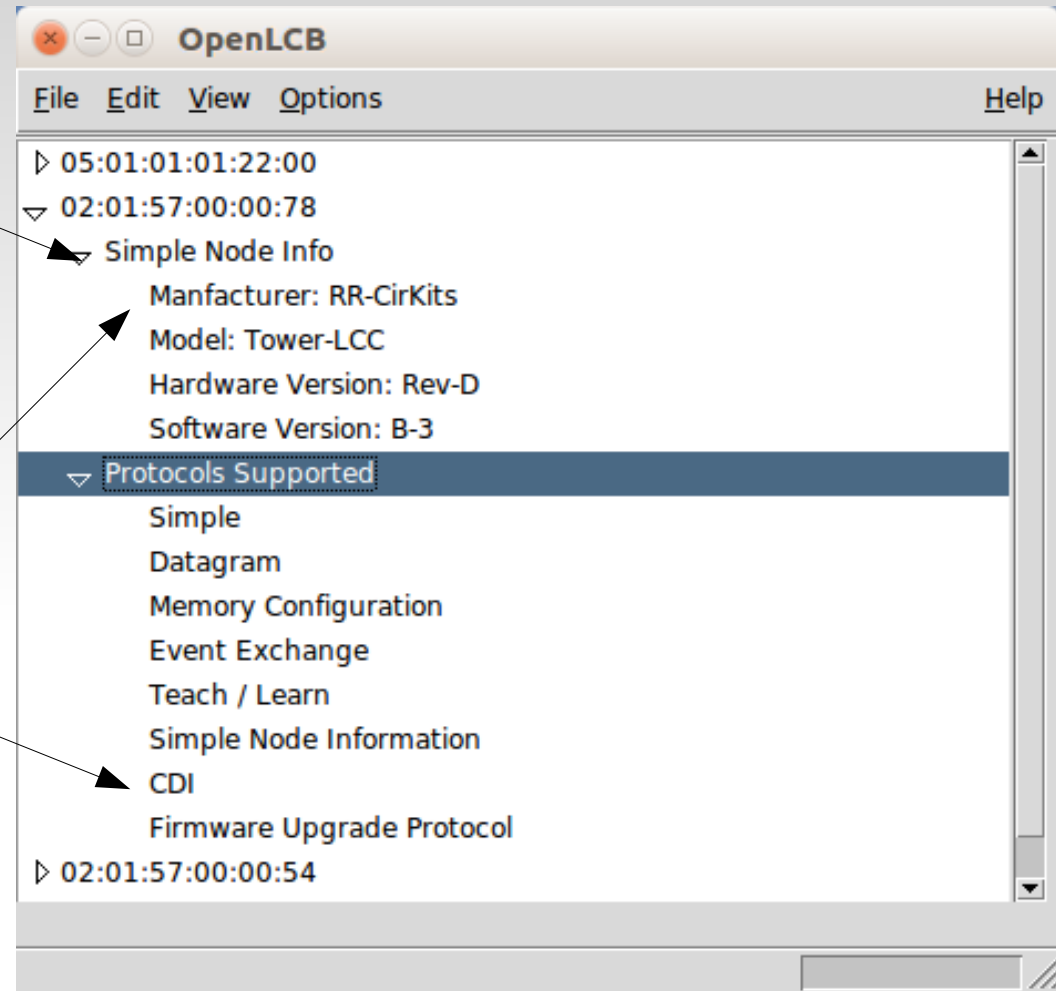

Be patient and you will be awarded with a usable presentation. (Similar to the new JMRI view)

Again the Node ID is found at the top of the window.

Node Identification follows.

Next is any Name and Description that you have given to the node. (be sure to click on 'Read' to see it).

The key difference is that the data is presented in a tab selected format. Note: the JMRI developers have created a similar improvement.

In this example we have selected 'CHANNELS' and 'Channel 1'.

In like manner, any repeated similar items are presented as tab choices.

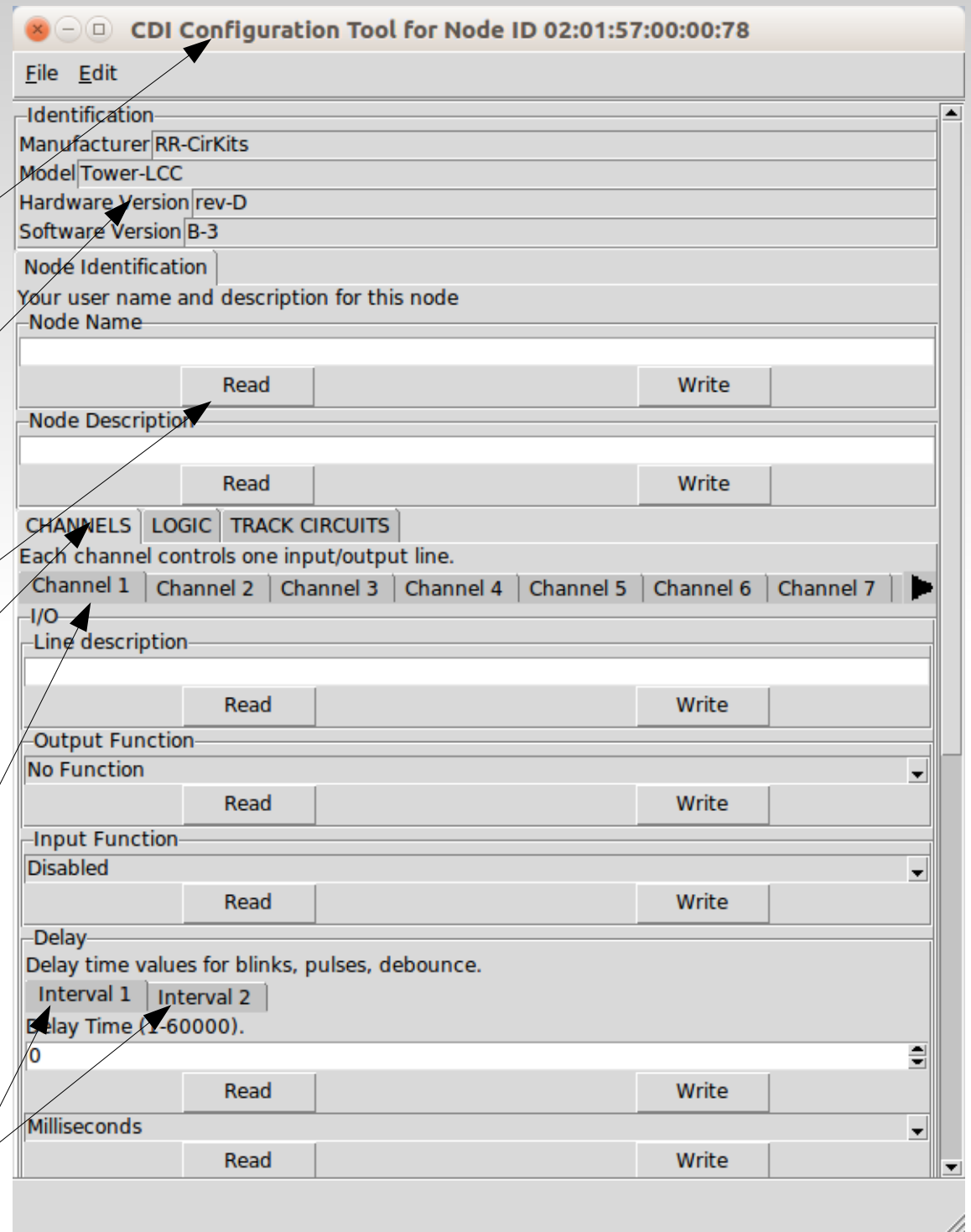

We have now entered a user comment for the line.

Be sure to click on 'Write' to save the item.

Normally you will need to set the Output as 'No Function' in order to use the line as an Input.

A list select arrow will present you with valid choices for some items.

In this example we have chosen the input to be 'Active Lo'. It responds as 'On' when being pulled low. (called negative logic) This is usual for many detectors and push buttons that turn 'on' by switching to the common ground.

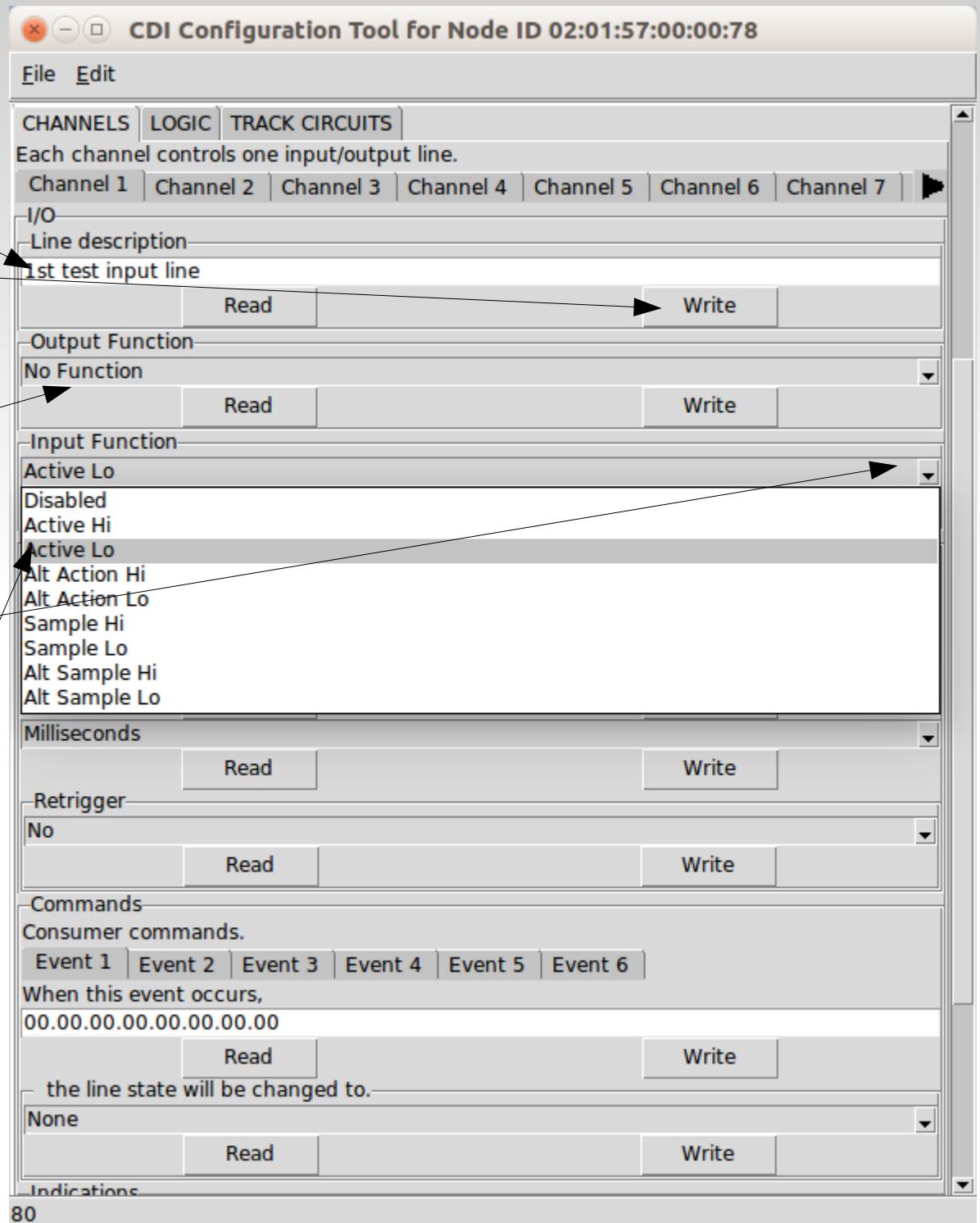

An input line is used to 'Produce' messages, so scroll down to the 'Indications' section and pick the first Event.

Select when the event is sent. For this first event it will be when the input is 'On'. (low per our initial setting)

For the event number you can either copy an event into the box from someplace else, or else click on 'Read' to get a new event.

Now select 'Event 2' and enter the data for the 'Input Off' event.

For simple setups the remaining events will be unused. Our button or detector or whatever is connected to the line will now send 02.01.57.00.00.78.00.06 when pressed (on) and 02.01.57.00.00.78.00.07 when released. (off)

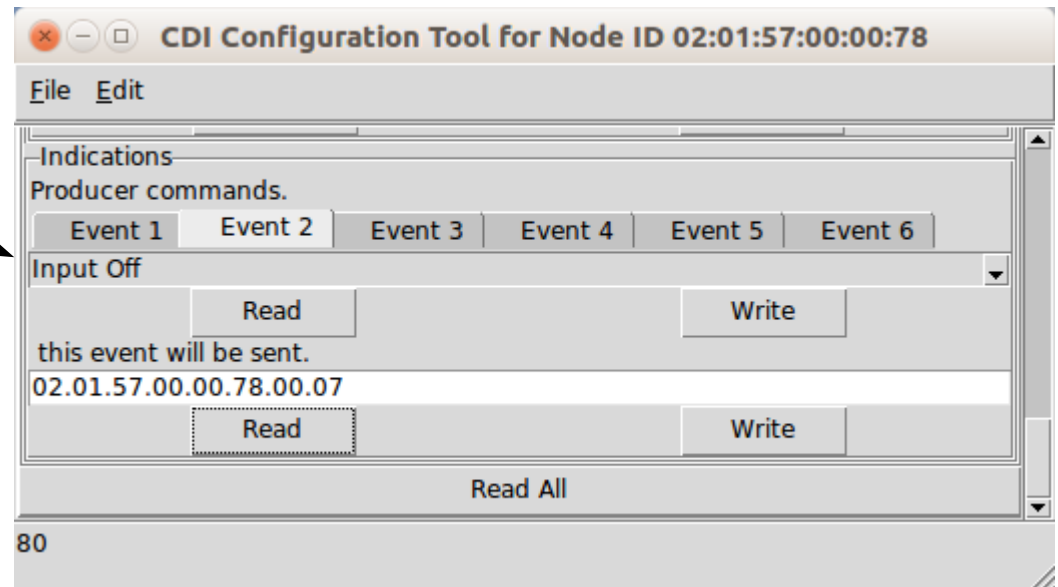
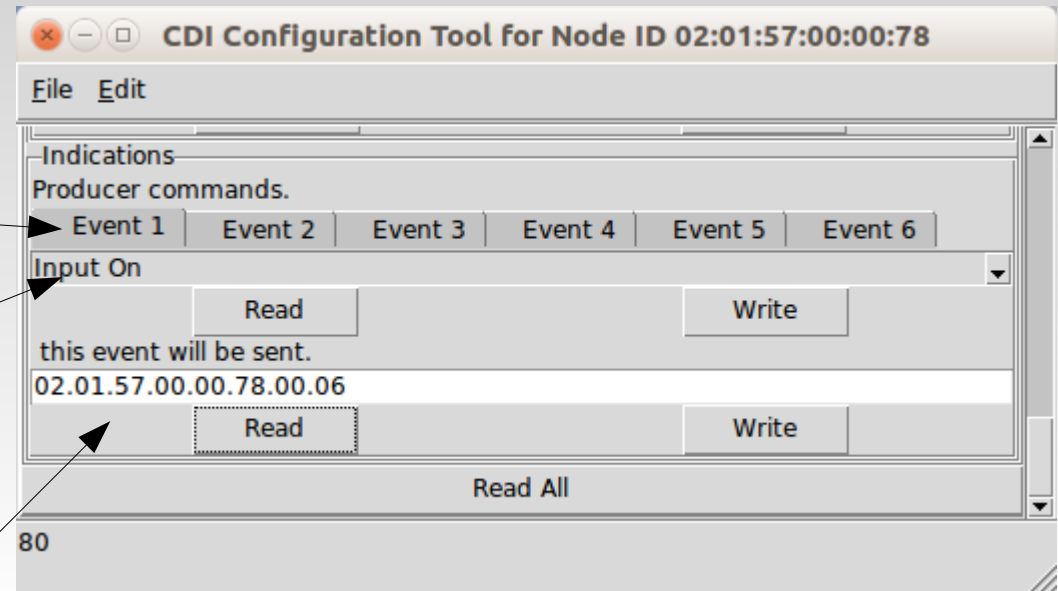

- In like manner outputs (Consumers) may be configured to respond to events. These Events may come from a JMRI program, other inputs, or even logic statements.
- Current configuration tools are still under development. One design target is to eliminate any reference to the actual EventID numbers, and simply use the users own names for items.
- I am not optimistic about seeing that in my lifetime, but once a line is configured you really can ignore the details of each EventID because you will not need to worry about any duplication, and you do not need to know them ahead of time to properly select the hardware like you do on existing networks. In LCC the hardware either offers you a new unused Event, or you may configure it to respond to your own already defined Events. (just copy your EventID to it)

## ■ Other Layout Animation

- Signaling is normally the most complex animation applied to a model railroad layout.
- Crossing gates and flashers with or without sound is another closely related animation that is often attempted by modelers. Commercial gate animators have various levels of sophistication, from simple on – off, control to reasonably accurate operation. I have seen designers twist themselves into knots trying to figure out how to do it accurately in both directions. However if you think in terms of Events it is actually very simple. Define two blocks. The first covers the entire gate *Approach* area. The second covers just the highway portion. We call it the *Island*.

The Logic:

1. Approach clear AND Island clear = gates up (requires memory of the two events plus AND logic)
2. Approach occupied event = gates down
3. Island occupied event = gates down
4. Island clear event = gates up



- Traffic signals. Simple flashers to full four or six cycle control.
- Building lighting and signage.
- Day – Night lighting.
- Street and parking lot lighting.
- Operating bridge spans.
- Warehouse doors.
- Mine skips.
- All of the above could be individual devices, or centrally controlled for even more realism. Building lights could follow room lighting, bright in the evening, off late at night, then on again early in the morning. Traffic signals go to flashing mode late at night. Warehouse doors open when trains arrive. Etc.

# Acknowledgements

Key OpenLCB Contributors: Bob Jacobsen, Alex Shepherd, David Harris, Stuart Baker, Balazs Racz, Jim Kueneman, Don Goodman-Wilson, John Plocher

## Developer Group

10 to 15 actively working on code at any time  
25 to 50 regular contributors and supporters  
Many of the same people as supporting JMRI

## User Group

Started November 2009  
July 2016 we have 226 addresses

NMRA liaison: Stephen Priest  
NMRA w.g. chairman: Karl Kobel

# Info

Yahoo Users Group

[openlcb@yahoo.com](mailto:openlcb@yahoo.com)

[LayoutCommandControl@yahoo.com](mailto:LayoutCommandControl@yahoo.com)

Useful Links

<http://openlcb.org>

<http://openlcb.com>

<http://nmra.org>, choose S&RP scroll to 9.7

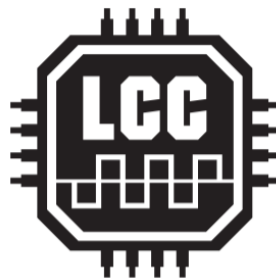
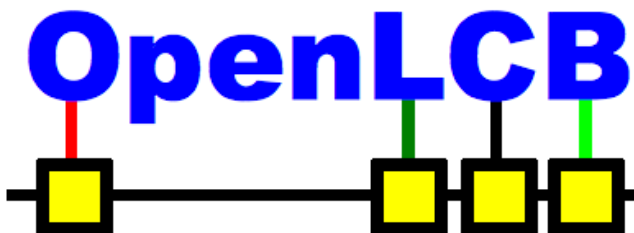

# Questions

- ?

# RR-CirKits

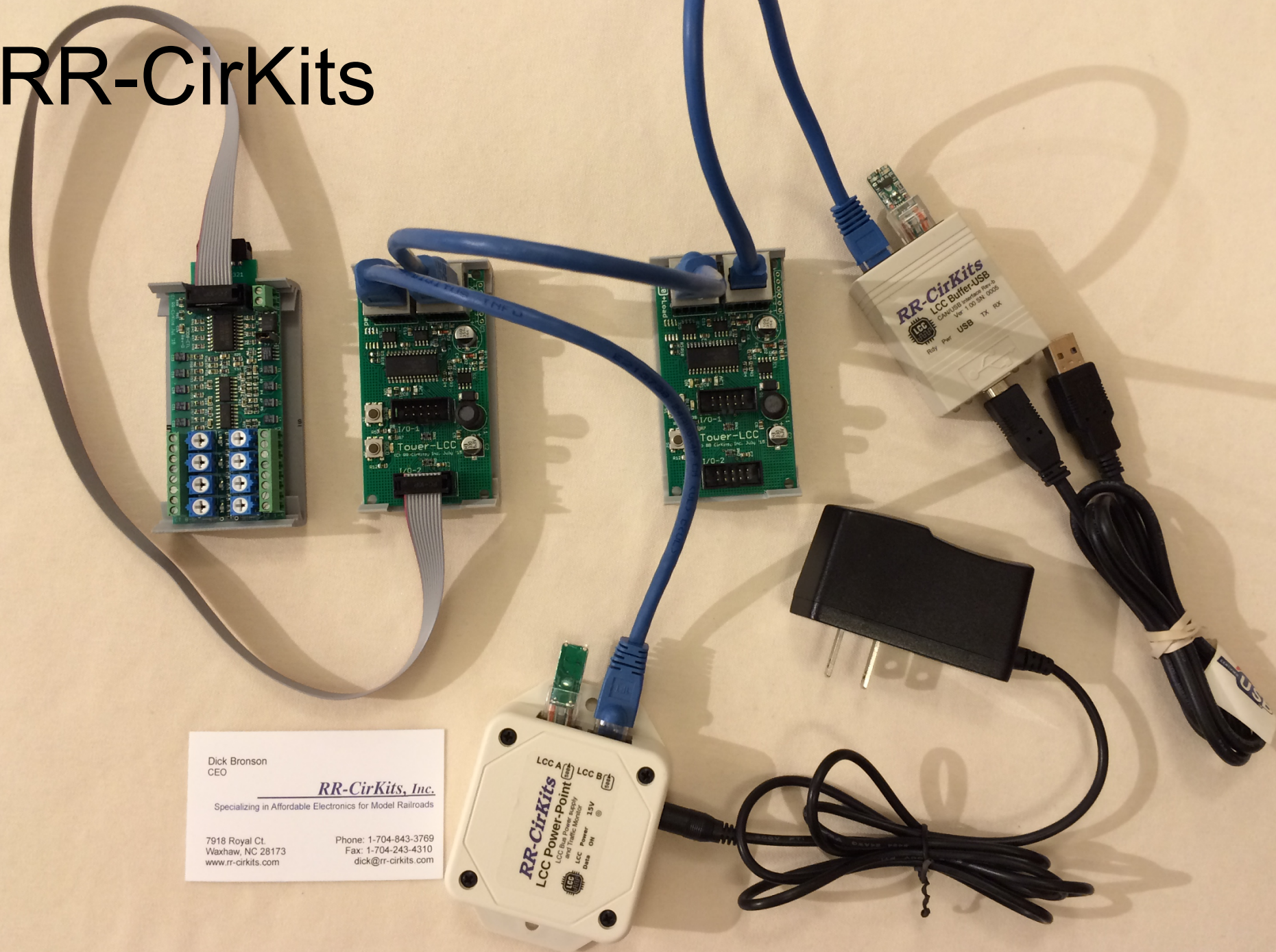

Dick Bronson  
CEO

**RR-CirKits, Inc.**  
Specializing in Affordable Electronics for Model Railroads

7918 Royal Ct.  
Waxhaw, NC 28173  
www.rr-cirkits.com

Phone: 1-704-843-3769  
Fax: 1-704-243-4310  
dick@rr-cirkits.com

# RR-CirKits

power and bus  
termination

**RR-CirKits, Inc.**  
Specializing in Affordable Electronics for Model Railroaders  
791 Royal Ct.  
Maysboro, NC 27557  
www.rr-cirkits.com  
Phone: 1-704-843-3768  
Fax: 1-704-243-4310  
dick@rr-cirkits.com

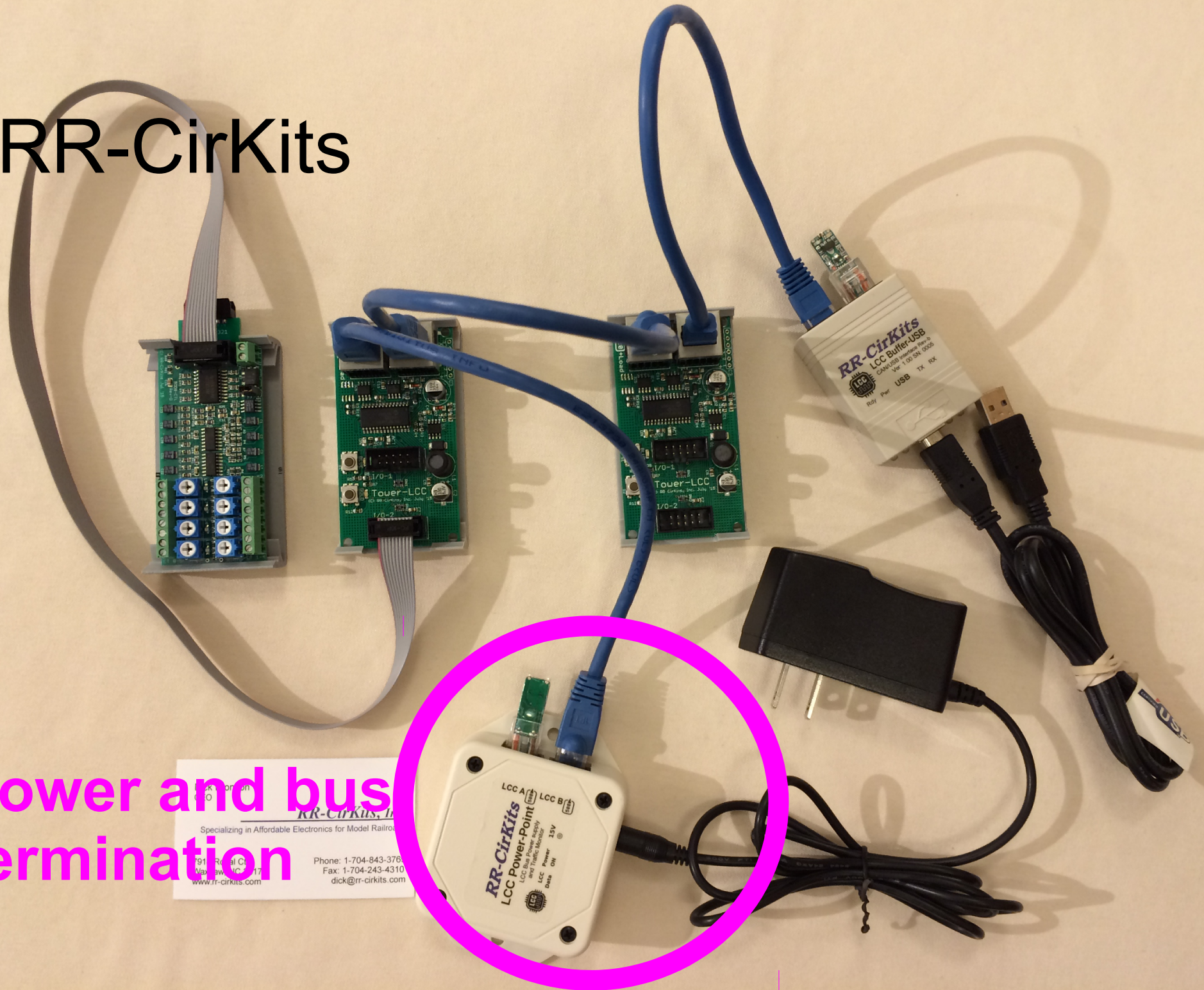

# RR-CirKits

computer  
interface

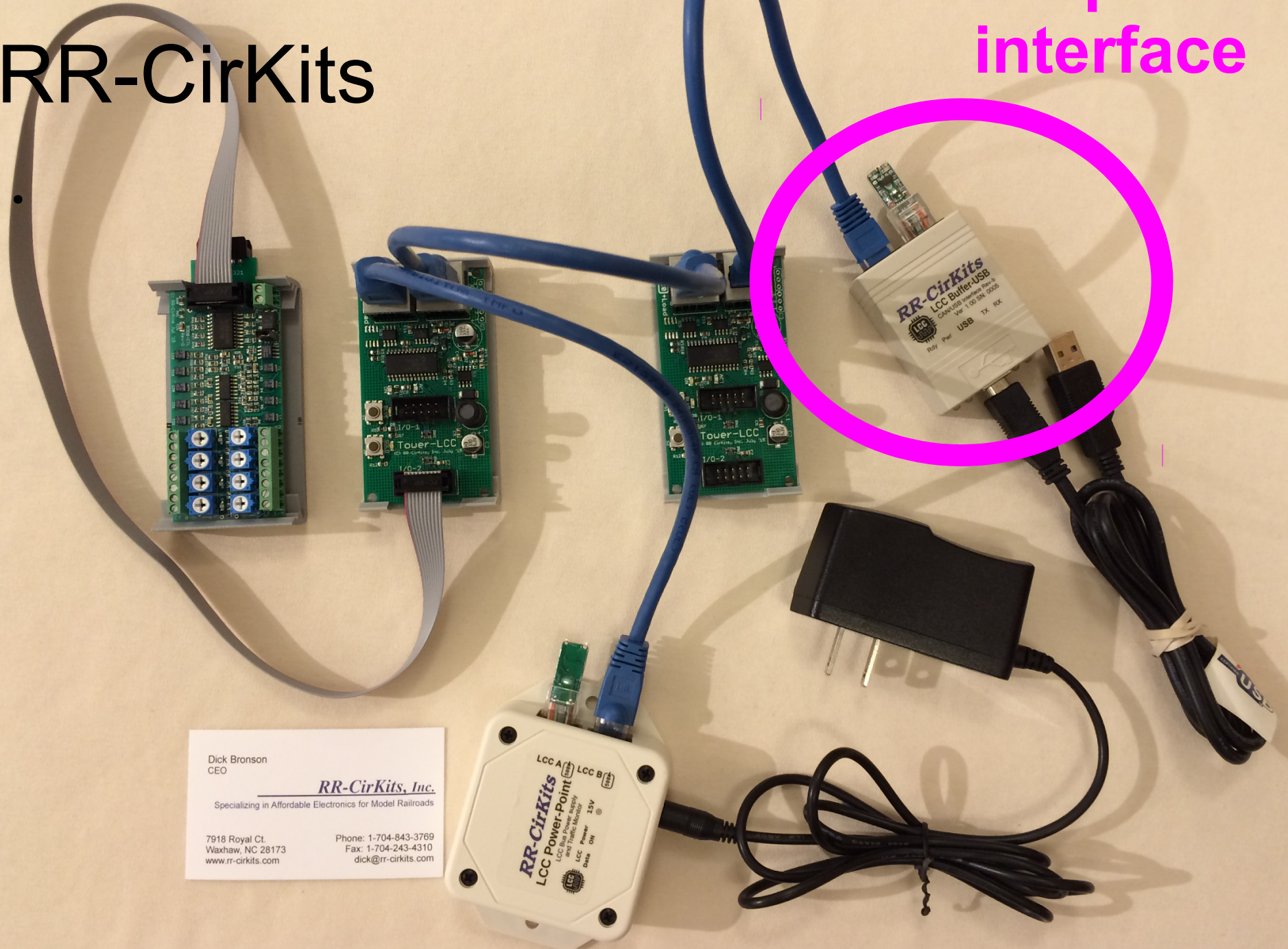

Dick Bronson  
CEO

**RR-CirKits, Inc.**  
Specializing in Affordable Electronics for Model Railroads

7918 Royal Ct.  
Waxhaw, NC 28173  
www.rr-cirkits.com

Phone: 1-704-843-3769  
Fax: 1-704-243-4310  
dick@rr-cirkits.com

LCC A LCC B

**RR-CirKits**  
LCC Power-Point  
LCC Plus Power Supply  
and Logic Memory  
LCC Data On

15V

# RR-CirKits LCC Smart Node

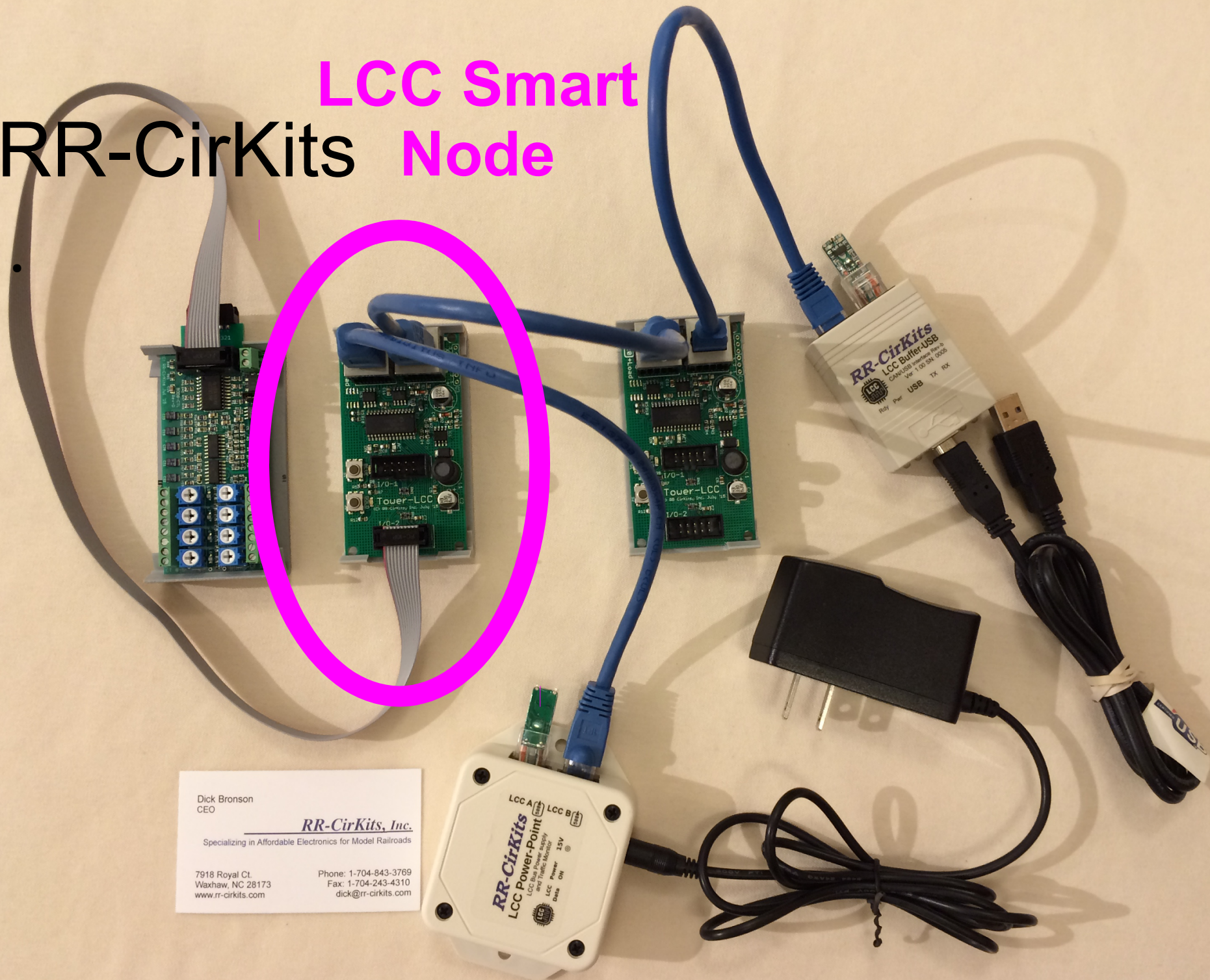

Dick Bronson  
CEO

**RR-CirKits, Inc.**  
Specializing in Affordable Electronics for Model Railroads

7918 Royal Ct.  
Waxhaw, NC 28173  
www.rr-cirkits.com

Phone: 1-704-843-3769  
Fax: 1-704-243-4310  
dick@rr-cirkits.com

RR-CirKits  
LCC Power-Point  
LCC Plus Power Supply  
and Public Memory  
LCC Data ON 13V

LCC A LCC B

RR-CirKits  
LCC Buffer-USB  
CAT5/USB module (Rev. 3)  
Ver. 00 09 0000  
Power USB TX RX



# RR-CirKits

all existing  
IO boards  
work

Dick Bronson  
CEO

**RR-CirKits, Inc.**

Specializing in Affordable Electronics for Model Railroads

7918 Royal Ct.  
Waxhaw, NC 28173  
www.rr-cirkits.com

Phone: 1-704-843-3769  
Fax: 1-704-243-4310  
dick@rr-cirkits.com

