

NMRA MER 2016

Tracks to the Triangle

Signaling Your Layout

Compiled by: Dick Bronson
RR-CirKits, Inc.

Installing a signaling system on your layout.

www.rr-cirkits.com/clinics/MER-2016-Signals.pdf

Types of Prototype Systems

- Train order signals
- Interlocking signals
- **ABS** (Automatic Block System)
- **APB** (Absolute Permissive Block)
- **CTC – TCS** (Centralized Traffic Control – Traffic Control System)
- Route indications
- Speed indications

Signal Types

Type	Variations	Unique Roads	Prototype Mfgs	HO Model Manufacturers
Ball Signals				
Semaphore	Upper, lower Quadrant		US&S, GRS	Tomar, N J International, (Oregon Rail Supply #152 #155 ??) Marklin
Search light	Smaller than normal background used by NYC	Used in many regions until modern times	US&S, GRS	BLMA, ISS, Tomar, Oregon Rail Supply
Color light	Stacked, V (Cat face)	Standard for modern signals	US&S, GRS, Safetran	BLMA, ISS, Oregon Rail Supply, Tomar, T.R. Castings, Details West, Atlas, Busch, Marklin, Model Power, Viessmann, Bachmann
Position Light	Route and Speed	Pennsy, LIRR, N&W, LV	US&S, GRS, Safetran	Tomar, ISS, NJI, Oregon Rail Supply
Color Position Light	B&O Speed only with 6 optional marker lights	B&O, N&W post 1959 with Route via 2nd heads	US&S, GRS	Tomar, ISS, NJ International, Oregon Rail Supply
Dwarf	N&W unique fan shaped CPL		US&S, GRS	Tomar, Oregon Rail Supply
Signal Bridges and Cantilevers				Overland, BLMA, Oregon Rail Supply
Train Order Boards			US&S, GRS	Tomar

Ball Signals



Whitefield Junction marks the crossing of the Maine Central Railroad and the Boston and Maine Railroad in Whitefield, NH. According to a plaque that stands near by this is/was the last remaining ball signal still in use in the United States.

Semaphore Signals



SP Extra 6516 West splits the lower quadrant semaphore signals at Winchester, TX

Upper Quadrant

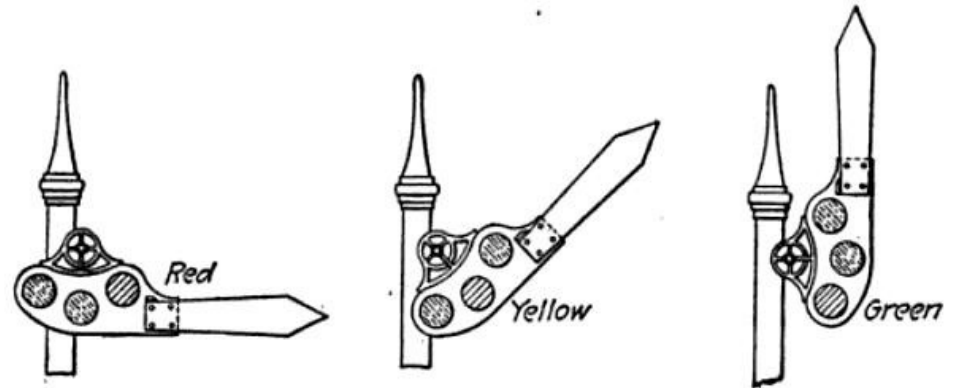

Lower Quadrant

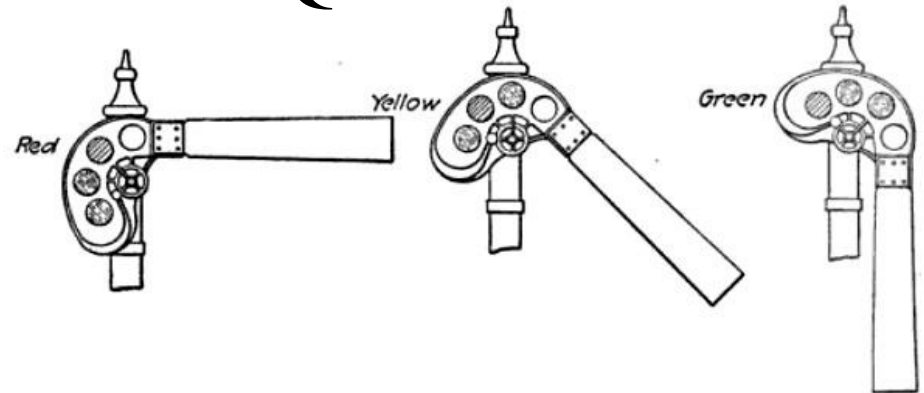

Semaphore Signals

SP semaphore signal base found on Craig's list in Arizona, and (hopefully) just delivered to me yesterday. This should allow me to get moving on my signal restoration project again. The desert is definitely easier on sheet steel and cast iron than the north east. This picture was taken just two weeks ago.

My previous PRR semaphore base was so badly rusted out and otherwise damaged that I had despaired of ever being able to restore it to operation. Fortunately my mast, ladders, and mechanism are still in somewhat better shape.

Because of the standardization in signals I think it will take a OCD rivet counter to tell that I will have grafted a PRR upper quadrant mast onto an SP lower quadrant base. Yes, there are differences. They could be simply different years of manufacture.



Searchlight Signals



Prototype



Model

Color Light Signals

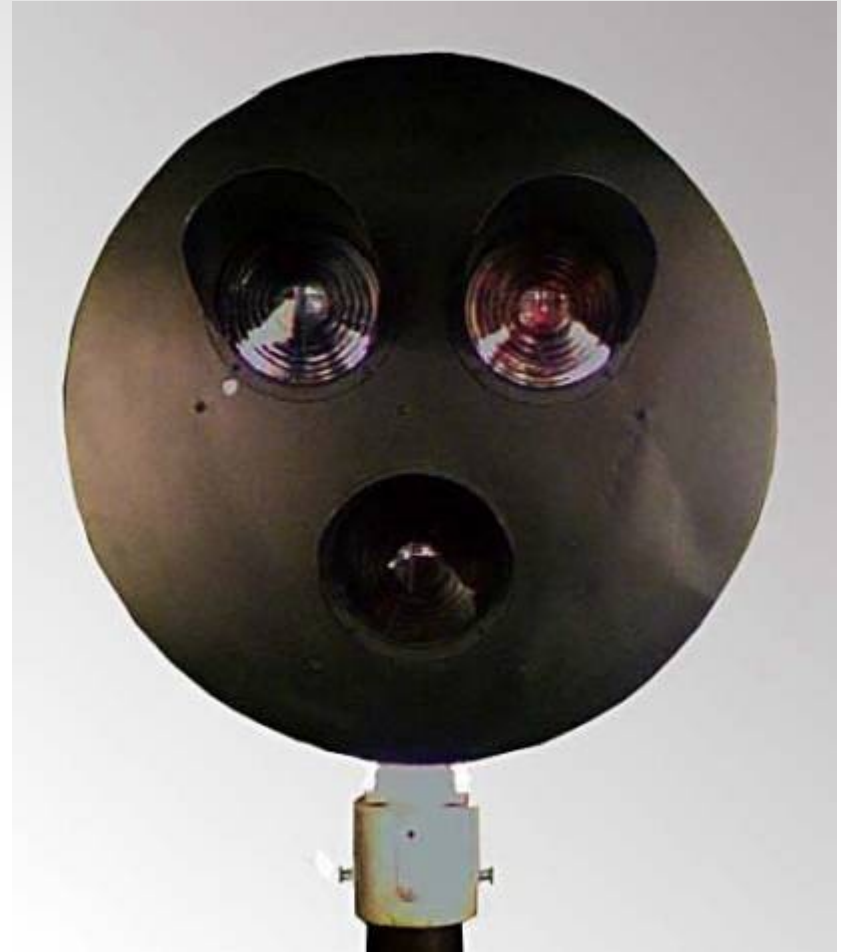

Position Light Signal



Mapleton, PA is the next set of signals west of Mt Union, about two miles away.

Position light signals were used by the Pennsylvania RR as well as the Norfolk and Western Railway, the LIRR, and Lehigh Valley RR.

Modernized (Amtrak) signals have had their horizontal lamps (stop indication) replaced with red lenses.

Todd Sestero
10/18/2008-Northumberland PA



Signal Bridges



Signal bridges were used when there was no room for individual masts. A long section of the AT&SF railroad had to resort to left hand running due to topology. The result was that the signal masts had to be placed to the left side because of FRA visibility rules. To prevent placing masts between tracks cantilevered signal bridges were used.

Doll (empty) masts were often used on signal bridges to mark unsignaled tracks.

Train Order Signals



Train order signals were 2 position semaphore style (usually) signals manually operated by the station agent when he needed to have a train pick up orders.

The rear brakeman on this Houston Power and Light coal train is just about to snag his copy of the train orders in front of the Santa Fe depot at McGregor, TX. The train is going into the siding to meet the afternoon Amtrak train on March 22, 1980.

Glossery of Signal terms

- ***Block*** is the section of track being protected by a signal. It does not necessarily correspond to the electrical blocks used for power distribution, but it is helpful if it does.
- ***Home Signal*** indicates the state of the block immediately ahead of the signal
- ***Distant Signal*** is a second signal (lower on the mast) showing the aspect of the next signal ahead. This should not be confused with the dual heads of a CTC system where the second head is used to indicate other conditions such as take the siding or a reduced speed. As signals became more complex a third 'approach' aspect was added to give this same information.
- ***Appearance*** is what the signal looks like. e.g. Red over Yellow.

- ***Aspect*** The name of the speed or route indication given by one or more signal heads or arms.
- ***Indication*** is what the aspect means. (what you need to do) These differ by railroad and era (hence are very useful for setting your railroad in a time and place). They can convey either route (common in the open West) or speed (common in the congested East) information. Signaled railroads provide an aspect chart in their ETT or rulebook.
- ***Signal Arm or Signal Head*** indicates each individual signal unit.
- ***Light*** The individual lamp in a signal. A light may indicate multiple aspects if it changes color like in a searchlight signal, or it may take multiple lights to indicate a single aspect, for example in position light signals.

- **Marker** is a signal head or arm that does not change color or position.
- **Mast** is the assembly that carries one or more signal heads. The engineer needs to consider that all signal heads on a single mast give a single indication or aspect. E.g. If its not all red, then its not red at all.
- **Rule** refers to the numbered entry in the prototype's publication governing the operating department. For example: from the 1937 NYCS rule book.

Rule 281: **Clear** Indication: Proceed

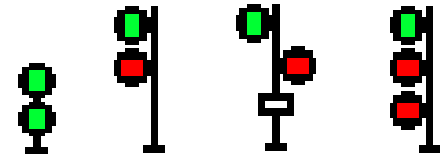

Rule 282: **Approach Medium** Indication: Proceed approaching next signal at medium speed

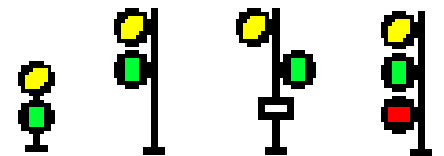

Manual Block System

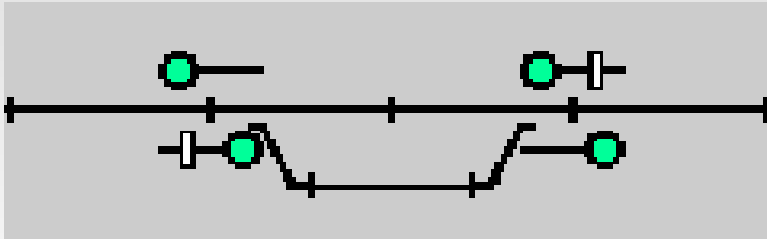

The Manual Block System is the simplest form of block signals. Each signal is manually operated by the operator at each station, based on information received by telephone, telegraph, or other methods of communication between stations. Manual Block does provide authority to use a track, and protect against opposing movements. This authority comes from the operators.

On this diagram you will see the typical manual block signal arrangement of two signals in each direction. The first controls the approach into the local siding, and the other the exit into single track.

The typical Manual Block signal only shows two aspects. Stop and Clear, or else Permissive (restricting) and Clear. (note number board)

ABS Signaling

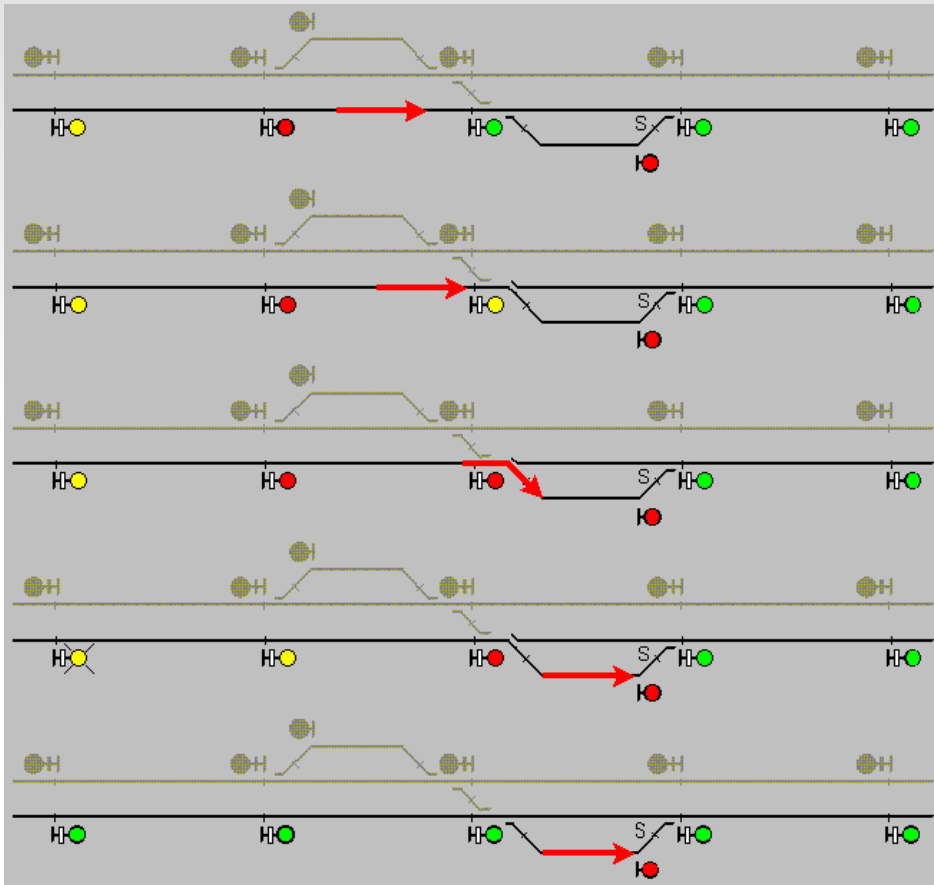

The ABS (Automatic Block Signaling or Automatic Block System) is a fully automated system. There is no remote or manual control of the signals, and they only show the status of the line ahead of the train. ABS does NOT provide authority to use a track, nor does it protect against opposing movements. Authority must still come from track warrants issued by a dispatcher.

On this diagram you will see that the ABS signals only protect a train from being overtaken from behind. There is not sufficient information to prevent approaching trains from colliding.

APB Signaling

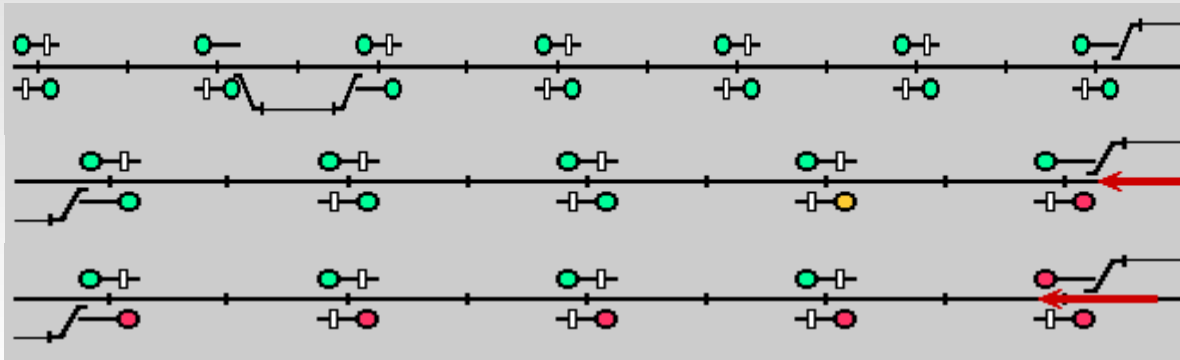

When a train passes the headblock signal and enters the track between two sidings, the APB sets all opposing signals down to the next (opposing) headblock signal to red, the so called tumble-down:

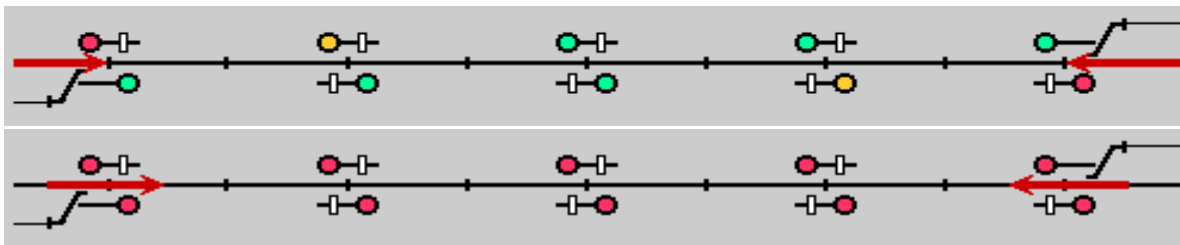

With at least three intermediate blocks, this gives protection even for the worst possible situation: Two trains simultaneously passing the headblock signals into the same section of line:

APB even with its improved protection is still NOT sufficient authority to occupy a track.

APB Signaling

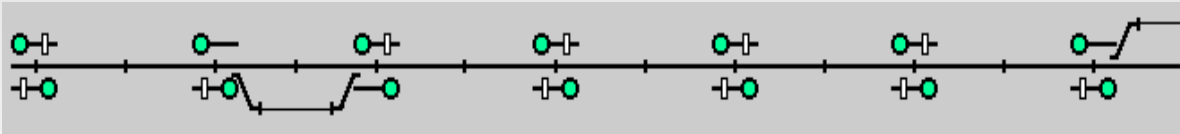

Note that the first signal protecting the single track does not have a number plate. This indicates an absolute stop. Some railroads will include a red marker lamp to reinforce this indication.

Both ABS and APB signals can be used to add enjoyment to the popular time table and train order based operating sessions. They are useful for the same reason that the prototype installed them. It allows for increased safety when multiple trains are operating in the same direction on the same track.

Essentially it gives remote eyes to the crew allowing them to see around curves and through tunnels. It also obviates the need to send out and recall flag protection to the rear of a stopped train or to drop fuzees along the way.

The other signals each have a number plate indicating that they are permissive signals. A permissive stop is like a highway stop sign. Stop, then proceed if it is safe to do so.

This means that a train facing the first signal must stop and stay, but trains in the single track section may stop and then proceed at restricted speed.

CTC Signaling

- CTC (Centralized Traffic Control) signaling starts out with a basic ABS or APB signal system which is called the 'vital logic'. The vital logic resides track side and responds immediately to local conditions.
- The dispatcher can only command (allow) a direction of traffic and turnout position. The local control point (the vital logic) is in charge of actually changing the signals and reporting back to the CTC operator if and when it has done so.
- The CTC system overlays the vital logic with information from the dispatchers machine. This information is in the form of command codes and indication codes. Because of the human element CTC does give operating authority to trains.

Control Codes

- To transmit a control code, the dispatcher positions the necessary levers on his CTC machine. Next, he pushes the appropriate code start button that causes the code to be transmitted. All field locations connected to the code line see the control codes, but only one station is selected. At the selected location, the control portion of the code is delivered through the field relays to cause the function relays to operate the switches, signals, etc.

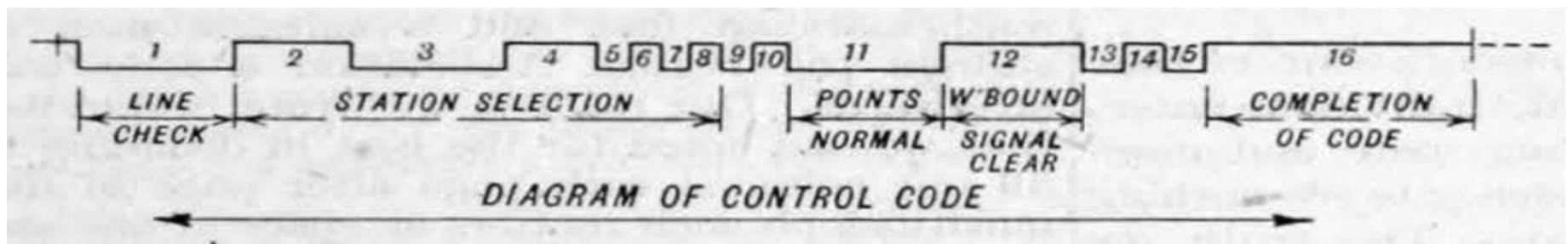

THE ENGINEER Sept. 17, 1943

Control Codes

- Each control code takes about $3\frac{3}{4}$ seconds to send. Each code consists of sixteen periods when the current is first 'on' then 'off'. Each of the periods may be long or short to indicate if its data is true or false. The first portion of the code selects the station and the remainder select the operations to be performed.
- The original system had a maximum capacity of 35 stations per line pair. Of course if the CTC machine was centrally located, then 70 stations could be controlled by a pair running in each direction. Each passing track consists of two stations.
- The classic CTC machine had 15 sections per panel. A large CTC machine would have 4 panels for a total of 60 stations using two code lines.

Indication Codes

- When a field change occurs in the position of a switch, the aspect of a signal, or the condition of a track circuit, an indication code is set up at the field location, which in turn automatically transmits the indication back to the CTC machine. When the indication code is received at the CTC machine, the appropriate indications light up on the dispatcher's panel to show him the conditions existing at the field locations.
- A similar method to that of the control codes is used by the field equipment to send the station indications back to the dispatcher.
- Only one code may be sent at one time to or from any station. If several stations need to send information, each is queued in priority until higher priority stations have completed sending.

CTC machine



Active Union Switch and Signal CTC machine at Amtrak's THORN Tower. This machine is direct acting, so it doesn't use a conventional code line for communication. It also includes additional controls for catenary power and heaters, plus dragging equipment indicators.

NMRA LCC (Layout Command and Control)

- What has been will be again, what has been done will be done again; there is nothing new under the sun.

Ecclesiastes 1:9

- In many ways the new LCC bus is similar to the original US&S code line on Steroids.
- Similarities:
 - All the data (both controls and indications) travels on one circuit.
 - Only one code may be sent at a time.
 - Messages are prioritized and queued if the line is busy.
 - Codes are only sent when something changes in the system.
 - Local equipment remembers these changes in order to display them.

NMRA LCC (Layout Command and Control)

- Differences:
 - Speed of operation: (8,000 times faster)
 - US&S 4 baud. (pulses per second) $\div 16 = 0.25$ message/sec
 - LCC (CAN bus) 125,000 baud. $\div 64 = 1,953$ message/sec
 - Number of station codes per code line:
 - US&S 30 out of 35 possible.
 - LCC up to 16,777,215 out of 4,294,967,295 possible.
 - Commands/Indications per Station:
 - US&S 7 commands and 7 indications.
 - LCC 65,535 total commands and indications.
 - Commands/Indications per message:
 - US&S 7. Each message set 7 relays to 'on' or 'off'.
 - LCC 1. Each message sends just 1 command. (eg. on)

Interlocking Plants

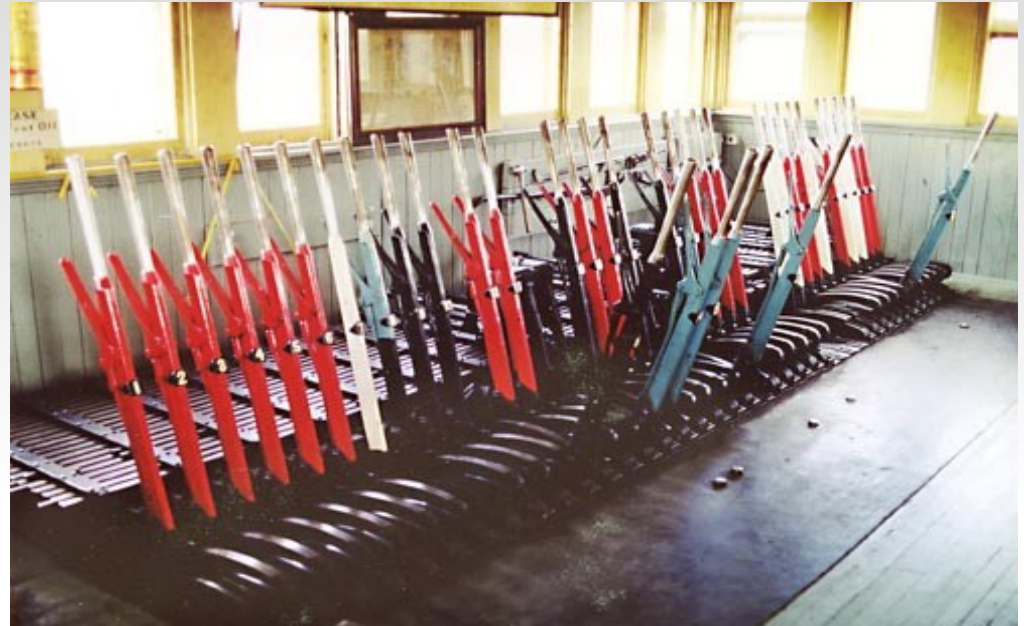

Interlocking Plants are used to protect crossings or junctions. Prior to the introduction of *Centralized Traffic Control (CTC)* in the 1920s, interlockings almost always had a manned tower with a towerman who controlled the switches and the signals protecting them with a system of levers and rods. These signals granted authority to enter the interlocking plant and were arranged so they could not display favorable aspects unless all switches were thrown properly, and any routes not selected were blocked. These were called Armstrong systems for a reason. The color coded levers indicate, signals (Red), spare (White), locks (Blue), and points (black). There are two positions, Normal (back), and Reverse (pulled forward), with latches in both positions. Thus "Signals Normal" means "Stop". The horizontal bars behind the levers slide back and forth to block all possible movement to any disallowed combinations of positions.

Typical CTC siding



Typical ABS/APB siding

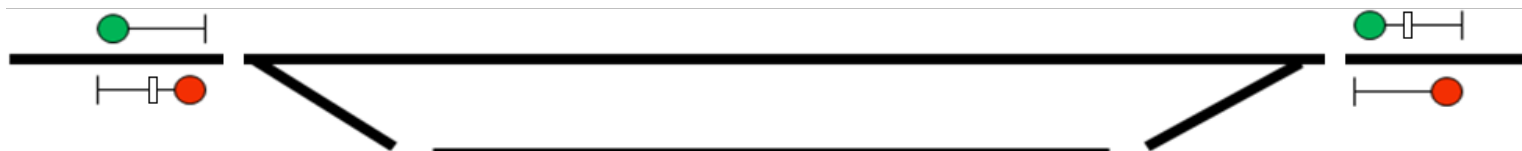

Note the different gaps and detection sections required for these two different signal options. The CTC turnouts are remote controlled, so FRA rules require that they be both detected and interlocked against movement under a train. Many CTC sidings are also occupancy detected.

ABS/APB turnouts on the other hand are manually controlled by the crew, and not interlocked. The signals are simpler because they do not tell the crew which direction the turnouts are positioned.

Model Signals

- Much of the following information was taken from the "Planning for Signals" discussion held by the LDSIG at the 2009-11 NMRA national conventions.
- Signals can be an exciting addition to a model railroad, adding color, realism, operating interest and functionality to your modeled scenes.
- Signals are more important than ever before because more of us are using DCC to run our trains realistically. This means that we are now experiencing some of the same issues that the prototype was encountering during the rapid growth during the late 19th and early 20th centuries.

- Early on in your consideration of adding signaling to your plan or existing layout, you'll need to choose, as you did in planning your layout, whether to model a prototypical scheme, a freelanced but prototype-based scheme, or freelanced signal elements that add some visual and operating interest but that don't follow any typical prototype engineering.
- Real-life railroad signaling is highly road, subdivision, and era specific. For maximum realism, you should obtain a copy of the rule book and special instructions and track charts, if available, for your division in the era you plan to model, or if freelancing based on a prototype, use the documents for one of the prototype roads you had in mind when you imagineered your railroad.

- If you think of planning a layout as telling a story, hardly anything you can do on your railroad will set it in a particular location and era like the correct signals, so spend some extra time finding photos and understanding the signaling system used.
- It's certainly possible to include some more generic elements in a freelanced scheme, but be warned that you may not find these as rewarding as a more realistic prototype-based system. Read on for more information to help you decide!
- Federal regulations and RR mergers are wiping out many of the former distinctions between signal systems. A modern layout will use the more generic recent signals and signal structures.

- Signals also help with operations: they convey authority to occupy track in interlocking plants, inform crews of train orders and may provide authority to occupy the main. If you are planning an operating layout you should consider how signals will help you with these requirements.
- Railroads use signals for four general purposes, although more than one may be used in any area (*interlockings*, *train order signals*, *safety overlay* (ABS/APB), and *traffic control* (CTC/TCS)). As modelers following a real or imagined prototype, we can use signals for these same purposes. This can greatly expand our enjoyment of our chosen hobby.

- Functional signals perform more or less as the prototype signals do, subject to selective compression, whereas cosmetic signals are just there to set the scene and perhaps do some very limited (or even incorrect) function such as turnout position indication.
- In the cosmetic case you might use operating or dummy signals and light them permanently or under control of a timer or slide switch, but be sure to put them in the right places. While these signals won't be used operationally, they will make your photo contest entries look great!
- Model Interlocking Plants often indicate the positions of turnouts so that operators don't run them. These can easily be wired to act as simple indicators, even if you don't want to provide all of the prototype functions

- Train Order Signals – The earliest TO signals were *ball signals* but typically they were semaphores until well into the early 20th century. Some search lights and other indicators were used later. These signals were always located at a train order office where an operator could transcribe orders from the Dispatcher and physically hand, or hoop them up, to train crews. Check prototype photos as train order signals were iconic and defined the look and era of a station.
- Some layouts only use signals cosmetically because the prototype had them. In this case you just need non functioning models placed in the correct places
- Cosmetic Signals can be further divided into *non-functional* and *semi-functional* approaches.

- *Non-functional* are dummy signals *properly located* at sidings, etc. (not used to indicate DC block boundaries, for example)
- *Semi-functional* are lighted (or movable in the case of Semaphores), but may not be tied to detailed signaling logic. They may be used to indicate turnout positions, whether adjacent DC blocks are assigned to the same or different cabs, reverse loop polarity, etc. I.e. useful but not prototypical functions.
 - Semi-functional signals may also provide a basic ABS like function without fully implementing prototype rules. I would place signal animators in this class. They will turn red as trains pass, but rely on a timer for their return to green.

- ***Functional*** Layouts with functional signals need all the stuff under the hood to make them work. There are several approaches to this ranging from, standardized logic modules, dedicated controllers, to software systems hosted on a personal computer. (E.g. JMRI, RR&Co.)
- In most cases the most difficult part is deciding what you want the signals to do. The difficulty of implementation depends on how closely you want to replicate the prototypical signal indications. Hardwiring signal logic increases the difficulty of implementation versus a software based system which can be edited or edited and compiled into a module. Many straightforward tools exist to help you implement the signal logic once you have determined what it should be. This is why we stress study of the prototype; your prototype will tell you what to do!

- Like the prototype, model signals may be controlled by individual wires....

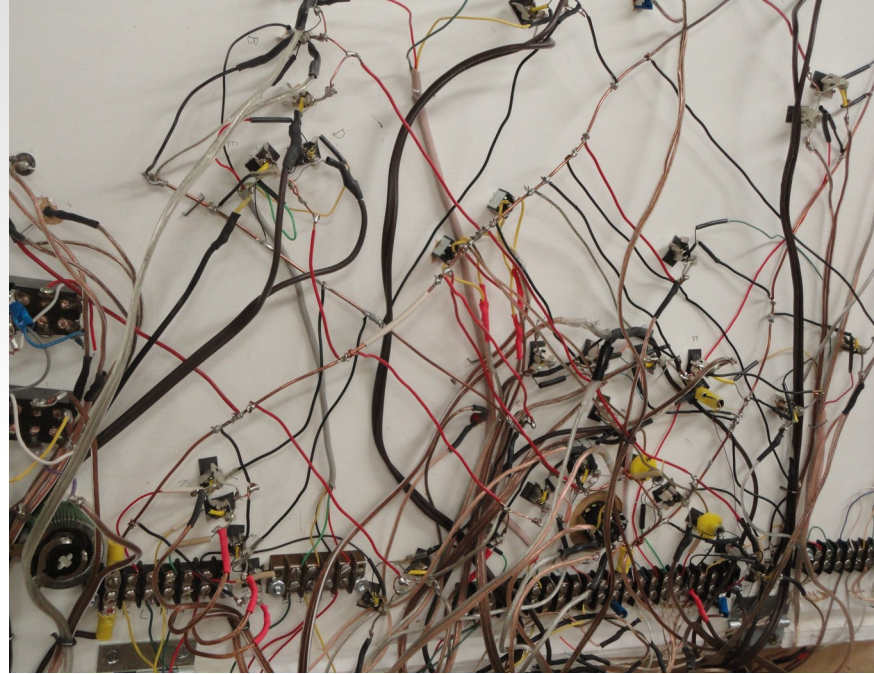

... or over a code line.



- Note the no longer used cross arms that may have carried communications circuits or signal circuits in the past. Only two of the remaining lower lines are used for the signals. Others may provide a voice circuit or power to the line side equipment. More likely the batteries are being charged from the local power line.

Other Considerations

- Signals should be aimed so the operators can see them (they may not be near the train) OR have repeaters (which may also help the color-weak operators). While cosmetic signals need only match the photo of the location you are modeling, operational signals must be able to tell your operators what to do, so they have to be able to see the *aspects* displayed! In many cases the prototypical orientation of signals will not permit viewing by the operator at a convenient point. Check each signal location and ensure that the signal will be visible. If it won't be, you can either modify the orientation so it is aimed at the operator (rather than at the 1/87th engineer) or provide *repeaters* on the fascia or valence. While repeating, if you are using *search light* signals on the layout, consider using color-lights on the repeaters as about 15% of males are color blind to some degree.

- Electrical infrastructure – Signaling systems depend on knowing where the trains are. Generally this done with block occupancy detection using current detection – somewhat like prototype track circuits – but optical detectors are sometimes used, especially for point solutions like grade crossing signals. You should map out where your signals are going to be located and what the detected blocks should be before you start power wiring. The track will need to be gapped accordingly.
- Be sure to check out our website at <http://www.rr-cirkits.com> for detection hardware and signal drivers.
- Check clearances (your widest locomotive and longest rolling stock may overhang more than the NMRA standards gauge which represents Plate C; your modern equipment may be plate F!). Make sure your dwarfs, pot signals and signal bases will clear. Western modelers: borrow an SP GS4 and be sure that huge pilot will clear!

- If you have equipment that exceeds the NMRA clearance gauge, check with that: a long wheelbase steam engine and full length passenger cars are a good torture test! Note the inside clearances on long cars with overhang, too. You may need to adjust your track to track spacing by an additional 0.5 inches or more. Signals are often located on curves which may exacerbate the overhang. Anyone have a Schnabel car?
- Relay sheds, boxes – the signal is just a series of lights with some kind of support. The track side “vital logic” had to be housed in some kind of enclosure: either in the base under the signal or a shanty nearby. These take up space on your right of way and need to clear your equipment. Be sure to include these little details along your right of way. They are an integral part of the signaling scene, and can make or break the impression of realism that we are trying to create. Even those folks that know nothing about signaling systems still have a sense of what looks right or wrong about a scene.

- Pole Lines – The signals need power and in the case of CTC, control. This was typically provided by the pole line which often carried telegraph or telephone as well. If you choose to model the pole line, it must go along the right of way and out of the way of your trains. Pole lines typically had at least one cross arm and often many more. Check prototype photos! Interestingly CTC systems did not necessarily have more cross arms as a single pair of “code wires” could control up to 80 miles of railroad. In more modern times, the pole lines have been superseded by radio or fiber optic and the pole lines are abandoned – a seldom modeled feature.
- Dispatcher and Operator positions
 - You will need a place to put the dispatcher who can control train order signals, CTC panels and the like. This may be in the layout room, or outside of it, and (preferably) sound isolated and not next to the coffee and chit-chat area.
 - Train Order operators should be placed somewhere near the station(s) they operate. This is best done while doing the basic track plan. This is often overlooked in planning!

Reality Check

- Most people don't have enough railroad to prototypically signal as we usually compress the space between towns:
 - To model a 5 block speed signaling for the Pennsy main you would need to have 5×1.25 trains \times 16 foot train = 100' of main per train in order to see a "high green" so most of us will need to compress.
 - Consider that the prototype typically stops 200-300 (3-5 engine lengths) feet ahead of the signal, this means that your 16' train is now $16' + 5$ engines = 19', pretty much filling a 20' block.

- Our OS sections are typically just the length of the switch, so each truck of every car must be detected to avoid drop outs using current detection. You may end up with a lot of very short blocks to make your system work. You may also need to supplement current detection with optical detection in some tricky areas.
- **How do you compress?**
 - Run shorter trains, then your blocks can be shorter.
 - Use fewer aspects: 2 or (3) block: clear, advance approach, approach and stop. While this won't have all the richness of the prototype it will provide usable information to your operators. If you can only get two blocks between towns (a luxury for most of us) only show two or three aspects.
 - You can simplify your interlockings by modeling fewer of the routes or eliminating some of the tricky cases.

- **What % of the total cost of your Railroad are you willing to devote to signaling?** Our (LDSIG) large system example is about 10% of the cost of plastic motive power and rolling stock. Since more than half of the cost of your signal system is in the signals themselves, it doesn't make sense to skimp on the control logic.
- **Plan for realistic implementation.** You'll need to know what your prototype (real or imagined) would do. Since signals have a number of purposes: protecting interlocking plants, safety overlays, and for traffic control, ask yourself what are you modeling? You'll need to define the physical appearance of the signals and in most cases you'll want to be very specific: which division of a particular railroad under a particular rulebook (date). The type of signals often defines the railroad, era, and location, so you will want to be accurate in your choices. Once you define the purpose of the signals and signals types used, you will need to plan your model right of way to accommodate them.
 - What did your prototype (real or imagined) use the signals for? Define these cases.

- What style of signals did your prototype use? This is the key visual feature of a signaled railroad and what we think of when we talk about planning for signals, depending on the road and era. (check photos)
- **Draw your track plan**
 - Indicate signal locations
 - Define the indications needed for each signal
 - Work out the conditions for each signal using a matrix or logic statements (this can be in plain English)
- **Planning feeders, gaps and blocks** (electrical infrastructure)
 - Determine (before you start wiring) how you are going to feed each block or if you are going to try do it all with optical detectors: I personally do not advise using optical detection for anything other than spot detection.

- Where will the gaps be?
- If CTC, don't forget to plan for the OS section detection.
- Blocks should be approximately 1.25 the length of typical train.
- Note that Signal Block boundaries will not necessarily be the same as DC or DCC block limits but they should not span multiple block (power district) or circuit breakers. This is dependent on the type of detection you use. Check your supplier's application notes. CT coil or other isolated designs will not be so limited.
- **Planning controls** (stuff under the hood)
 - CMRI/JMRI
 - Digitrax/JMRI (Our RR-CirKits equipment is compatible with this option.)
 - LCC stand alone, LCC/JMRI. What does the future hold?
 - Dedicated hardware. Commercial or home built.
 - Simple diode/relay logic for small interlockings.
 - Control panels and CTC hardware. Monitors or hard panels?

■ Other Layout Animation

- Signaling is normally the most complex animation applied to a model railroad layout.
- Crossing gates and flashers with or without sound is another closely related animation that is often attempted by modlers.

Commercial gate animators have various levels of sophistication, from simple on – off, control to reasonably accurate operation. I have seen designers twist themselves into knots trying to figure out how to do it accurately in both directions. However if you think in terms of Events it is actually quite simple. Define two blocks. The first covers the entire gate *approach* area. The second covers just the highway portion. We call it the *island*.

The Logic:

1. Approach clear AND island clear = gates up (requires memory of the two events plus AND logic)
2. Approach occupied event = gates down
3. Island occupied event = gates down
4. Island clear event = gates up

- Traffic signals. Simple flashers to full four or six cycle control.
- Building lighting and signage.
- Day – Night lighting.
- Street and parking lot lighting.
- Operating bridge spans. (interlocked with signals)
- Warehouse doors.
- Mine skips.
- All the above can be individual devices, or centrally controlled for even more realism. Building lights follow room lighting, bright in the evening, off late at night, then on again early in the morning. Traffic signals go to flashing mode late at night. Warehouse doors open when trains arrive. Etc.

Questions

- ?